

**SPECIFIC PLAN NO. 66
MADERA AT CITRUS TRAIL**

CITY OF REDLANDS, CALIFORNIA

December 14, 2023

*A Residential Community in
the City of Redlands*

Applicant

Vanita Soni Puri
Soni 2012 Irrevocable Trust
1423 Georgina Avenue
Santa Monica, CA 90402
(949) 922-7075

LIST OF CONSULTANTS

Planning

URBAN ENVIRONS
307 Brookside Avenue
Redlands, CA 92373
(909) 798-4446

Civil Engineering

CA ENGINEERING, INC.
13821 Newport Avenue, Suite 110
Tustin, CA 92780
(949) 724-9480

Landscape Architecture

SITESCAPES LANDSCAPE
3190-82 Airport Loop Drive
Costa Mesa, CA 92626
(949) 644-9370

Architecture

KTGY ARCHITECTURE & PLANNING
17911 Von Karman Avenue, Suite 200
Irvine, CA 92614
(949) 851-2133

TABLE OF CONTENTS

Preface.....	5
--------------	---

SECTION 1. INTRODUCTION AND BACKGROUND

A. Introduction.....	6
1. Purpose and Intent.....	6
B. Project Setting.....	7
1. Project Location	7
2. Legal Description.....	7
3. Project Description	11
C. Project Goals and Objectives	13
D. Relationship to the City's General Plan.....	14
E. General Notes.....	17

SECTION 2. MASTER PLANS

A. Land Use.....	18
B. Circulation Plan.....	20
C. Infrastructure Plan.....	23
1. Water	23
2. Sewer.....	23
3. Storm Drainage	23
D. Conceptual Landscape Plan.....	28
E. Conceptual Architecture.....	37

SECTION 3. DEVELOPMENT STANDARDS

1. Permitted Uses.....	47
2. Accessory Uses.....	47
3. Property Development Standards	47

SECTION 4. PROCEDURAL IMPLEMENTATION

A. Specific Plan	48
B. Subdivision Map.....	48
C. Commission Review and Approval	48
D. Phasing and Maintenance Responsibility	48

LIST OF EXHIBITS

Exhibit 1 – Project Location	8
Exhibit 1.1 – Topographical Survey.....	9
Exhibit 2 – Project Boundaries / Existing Conditions	10
Exhibit 3 – Illustrative Site Plan	12
Exhibit 4 – Land Use Plan.....	19
Exhibit 5 – Circulation Plan.....	21
Exhibit 6 – Typical Street Sections	22
Exhibit 7 – Domestic Water Plan	25
Exhibit 8 – Sanitary Sewer Plan	26
Exhibit 9 – Drainage Plan	27
Exhibit 10 – Conceptual Landscape Plan.....	29
Exhibit 11 – Community Park Plan.....	30
Exhibit 11.1 – Community Park Scene.....	31
Exhibit 11.2 – Community Park Scene.....	32
Exhibit 12 – Typical Motor Court Plan.....	33
Exhibit 13 – Motor Court Enlargement.....	34
Exhibit 13.1 – Motor Court Scene.....	35
Exhibit 14 – Fence and Wall Plan.....	36
Exhibit 15 – Conceptual Plotting	39
Exhibit 16 – Conceptual Floor Plan - Plan 1	40
Exhibit 17 – Conceptual Floor Plan - Plan 2.....	41
Exhibit 18 – Conceptual Floor Plan - Plan 3.....	42
Exhibit 19 – Architectural Styles	43
Exhibit 20 – Interior Streetscape Scene	44
Exhibit 21 – Community Edge Enhancements (Wabash Avenue).....	45
Exhibit 22 – Community Edge Enhancements (Colton Avenue)	46

PREFACE

Specific Plan No. 66, has been written and prepared to serve as a planning tool for the City of Redlands to review a residential community with unique design characteristics. This Specific Plan No. 66 has been prepared according to accepted professional principles fulfilling the criteria of the City of Redlands. In the preparation of the Specific Plan, a commitment has been made to produce a unique residential community integrated with abundant open space and amenities. The land owner has assembled a team of architects, landscape architects, civil engineers and city planners which have strived to produce a master-planned residential community incorporating small lot housing under a motor court design of single family homes.

SECTION 1. INTRODUCTION AND BACKGROUND

A. Introduction

1. Purpose and Intent

The Specific Plan No. 66 is intended to provide the framework and property guidelines for the design and development of a master-planned residential community in conformance with the goals and objectives of the City of Redlands General Plan. Specific Plan No. 66 has been written and prepared to focus upon design solutions, regulations and development standards specifically tailored to the project site and residential design while insuring a commitment to the ordinances of the City of Redlands in both spirit and intent. The Specific Plan intends to develop a residential community in such a manner so as to produce a cohesive, unified development sensitive to the project site and surrounding area through the integration of special buffer treatments, architectural theming, placement of structures, and the integration of passive and active open space and recreational uses. The incorporation of the design guidelines and development standards contained in the Specific Plan will provide the City of Redlands with a desirable residential neighborhood with abundant amenities and housing opportunities.

The Specific Plan includes text and exhibits which specify the following in detail:

- The distribution, location, and extent of the uses of the land, including open space, within the area covered by the Specific Plan.
- The proposed distribution, location, and extent and intensity of major components of public or private transportation, sewage, water, drainage, solid waste disposal, energy, and other essential facilities to be located within the area covered by the plan and needed to support the land uses described in the plan.
- Standards and criteria by which development will proceed.
- A program of implementation measures including regulations, programs, public works projects, and financing measures necessary to carry out the project.
- The Specific Plan shall include a statement of the relationship of the Specific Plan to the General Plan.

8. Project Setting

1. Project Location

Specific Plan No. 66 encompasses approximately 9.01 acres located at the northwest corner of Wabash Avenue and Colton Avenue, along the City's eastern city limit. Exhibit 1 depicts the Regional Setting of the project site, while Exhibit 2 depicts the Project Boundaries, in addition to its relationship to the surrounding area. To the north of the project site is a residential subdivision of single family homes; to the west of the site is a mobile home park; to the south of the project site is a mobile home park; and, to the east are industrial buildings located in an unincorporated portion of San Bernardino County.

The site is relatively flat, having a gentle slope (2%) from east to west. The project site is currently vacant land.

2. Legal Description

The land referred to herein is situated in the City of Redlands, County of San Bernardino, State of California, and is described as a portion of the Southeast Quarter of Section 24, Township 1 South, Range 3 West, San Bernardino Base and Meridian.

The land consists of the following Assessor's Parcel:

APN 0168-291-020-000 9.01 acres

EXHIBIT 1
PROJECT LOCATION

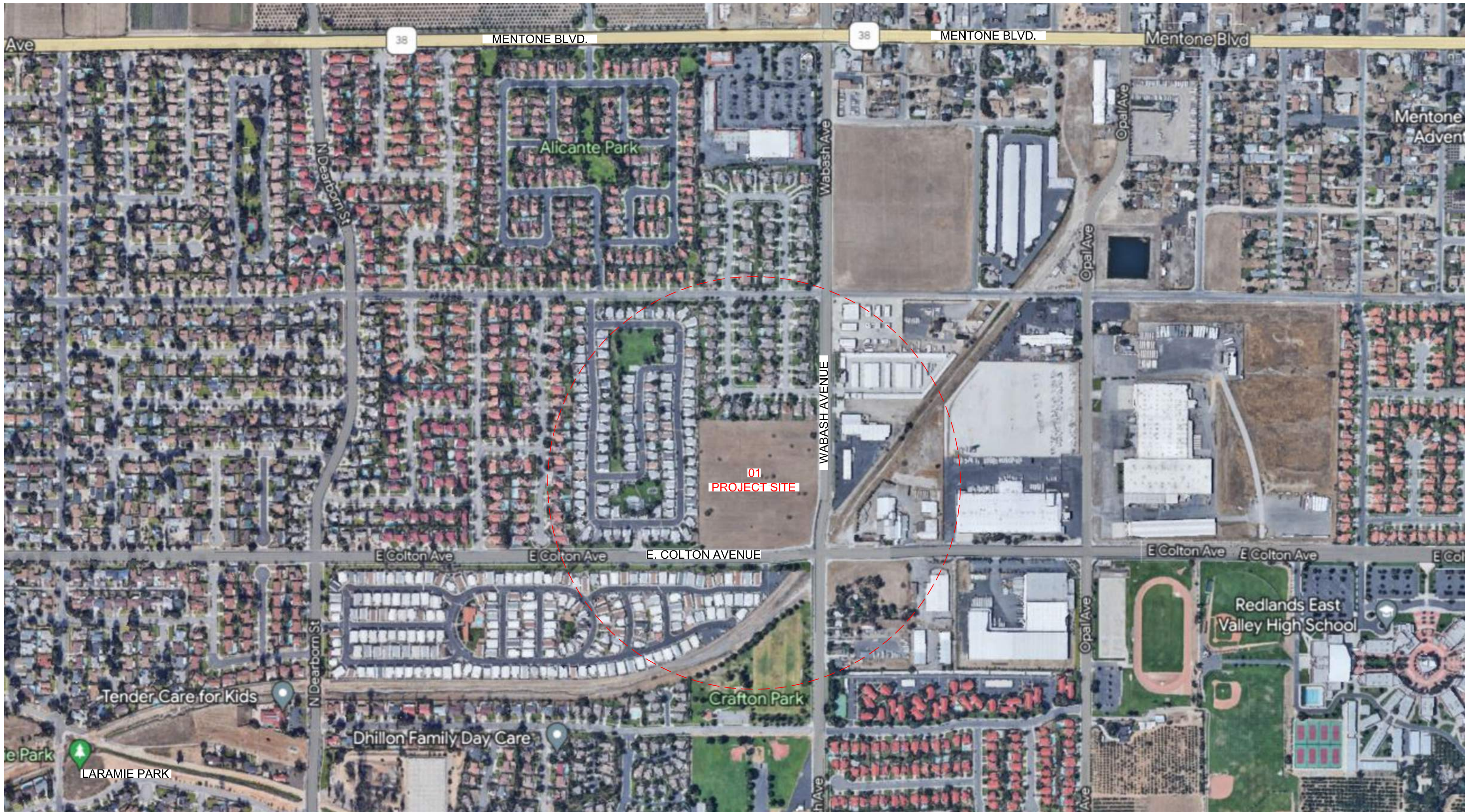

Soni 2012 Irrevocable Trusts
 1423 Georgina Avenue Santa Monica
 Santa Monica, CA 90402
 (949) 922-7075
 Contact: Vanita Soni Puri

CA ENGINEERING, INC.
 Planning • Engineering • Surveying
 13821 NEWPORT AVE., STE 110
 TUSTIN, CA 92780
 949-724-9480 949-724-9484 FAX



SITE SCAPES
 Landscape Architecture & Planning
 3190-82 Airport Loop Drive
 Costa Mesa, CA 92626
 Robert Fulkerson, License # 2782
 (949) 644-9370 FAX (714) 210-3140

MADERA AT CITRUS TRAIL
 SPECIFIC PLAN

EXHIBIT 1.1
TOPOGRAPHICAL SURVEY

EXISTING TOPOGRAPHY

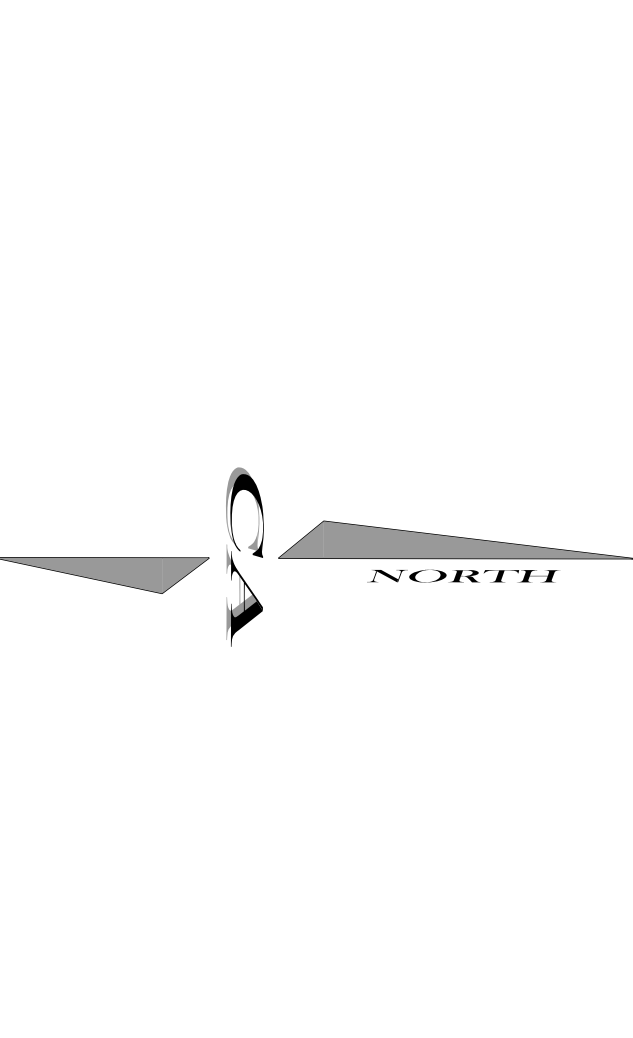
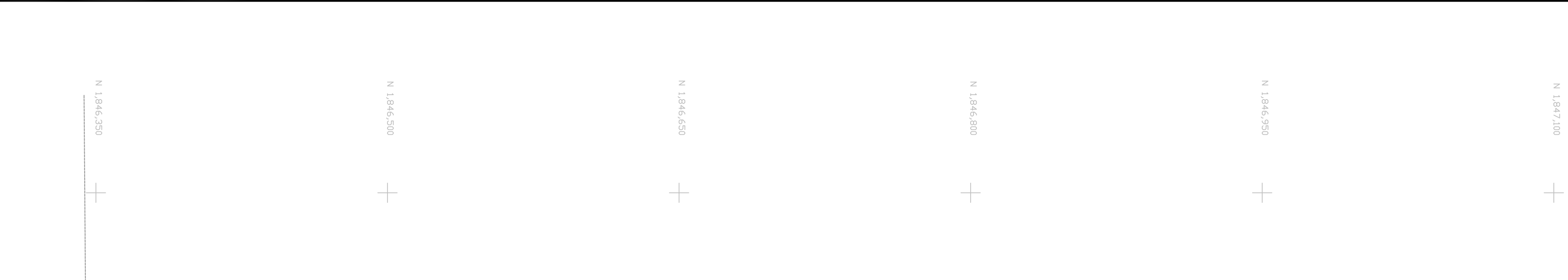
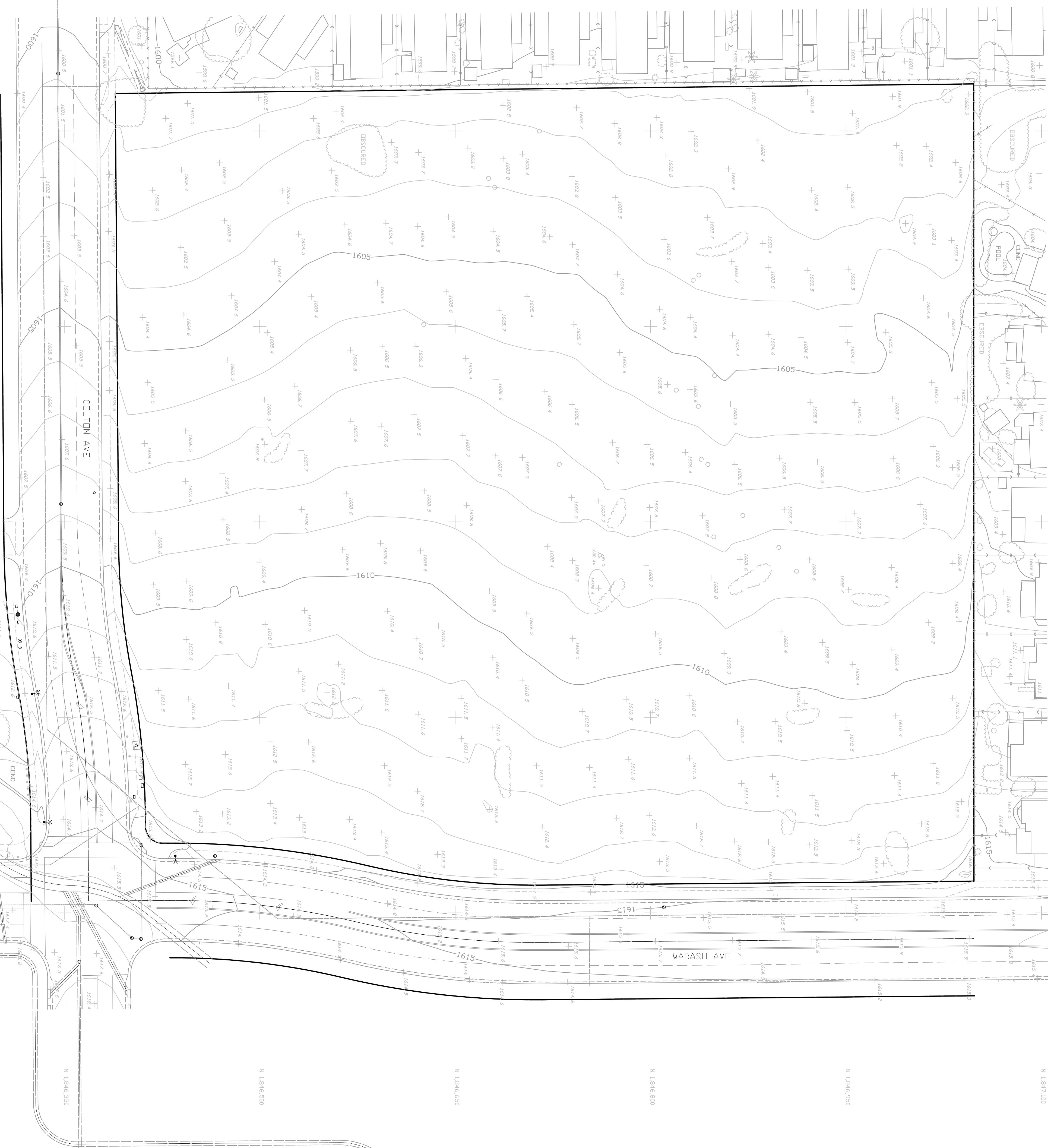

PREPARED BY:
CA ENGINEERING, INC.
Planning • Engineering • Surveying
1821 NEWPORT AVE, STE 110
SAN JOSE, CA 95131
949-724-9400 949-724-9404 FAX

SUBDIVIDER/OWNER:
Soni 2012 Irrevocable Trusts
1423 Georgia Avenue Santa Monica
Santa Monica, CA 90402
(349) 922-7075
Contact: Vanita Soni Puri

ADDRESS:
E Colton Ave. and Wabash Ave.
Redlands, CA 92374

BY	DATE

REVISIONS

BY	DATE

EXHIBIT 2

PROJECT BOUNDARIES/EXISTING CONDITIONS



Soni 2012 Irrevocable Trusts
 1423 Georgina Avenue Santa Monica
 Santa Monica, CA 90402
 (949) 922-7075
 Contact: Vanita Soni Puri

CA ENGINEERING, INC.
 Planning • Engineering • Surveying
 13821 NEWPORT AVE., STE 110
 TUSTIN, CA 92780
 949-724-9480 949-724-9484 FAX



SITE SCAPES
 Landscape Architecture & Planning
 3190-82 Airport Loop Drive
 Costa Mesa, CA 92626
 Richard Fothman, License # 2782
 (949) 644-9370 FAX (714) 210-5140

MADERA AT CITRUS TRAIL
 SPECIFIC PLAN

3. Project Description

The concept of Specific Plan No. 66 is to provide the planning framework which will guide the future development of the project site in a manner that responds to the unique characteristics of the site, fosters a sense of community and neighborhood, and responds to the residential market conditions of the City of Redlands. The master-planned residential development envisioned by this specific plan will complement the existing neighborhood and will provide additional housing opportunities.

The Specific Plan has been prepared in the spirit and intent with the City's Planned Residential Development Regulations (PRO). The PRO is defined as a development located on a site approved as a subdivision, to be constructed by a person or corporate body, involving a variety of residential structure types, planned as a total entity and, therefore, subject to approval, development and regulation as one land use complex. The purpose of the PRO provisions is to provide for greater flexibility in the design of residential developments and the promotion of a more efficient, aesthetically pleasing and desirable use of land.

An Illustrative Site Plan is depicted in Exhibit 3, representing a conceptual depiction of the development as proposed within this Specific Plan.

The project has been designed as motor court housing, consisting of 102 single family homes integrated with active and passive open space. An additional 1.72 acres of common open space and 1.96 acres of private open space is proposed. The 3.68 acres of open space represents 43% of the project site excluding public street perimeters. The interior street system is a combination of private streets and alleys servicing the individual units.

EXHIBIT 3
ILLUSTRATIVE SITE PLAN



SITE PLAN



Soni 2012 Irrevocable Trusts
 1423 Georgina Avenue Santa Monica
 Santa Monica, CA 90402
 (949) 922-7075
 Contact: Vanita Soni Puri

CA ENGINEERING, INC.
 Planning • Engineering • Surveying
 13821 NEWPORT AVE, STE 110
 TUSTIN, CA 92780
 949-724-9480 949-724-9484 FAX

S I T E S C A P E S
 Landscape Architecture & Planning
 3190-B2 Airport Loop Drive
 Costa Mesa, CA 92626
 Robert Polovina, License # 3782
 (949) 644-9370 FAX (714) 210-3140
 JOB# 22-026 DATE: 12-12-23

MADERA AT CITRUS TRAIL
 SPECIFIC PLAN

C. Project Goals and Objectives

The concept of the Specific Plan is to provide a framework which will guide the future development of the project site in a manner which responds to the unique characteristics of the site and fosters a sense of community identity. In order to ensure the creation of a superior residential community sensitive to the needs of the Redlands community, the following goals and objectives have been incorporated:

- The creation of an enriched residential community taking advantage of the characteristics of the project site.
- To establish an aesthetically appealing project along Wabash Avenue and Colton Avenue by incorporating attractive site planning techniques, architectural design, and incorporating an abundant amount of visible open space.
- To foster a sense of community and pride within the residential neighborhoods comprising the project site.
- To insure the compatibility with surrounding land uses and residential neighborhoods through utilization of landscaping and buffer treatments as well sensitive site planning techniques.
- To locate initial phases of development in coordination with the extension of public services and infrastructure.
- To provide a circulation system to conveniently serve the needs of the development.

D. Relationship to the City's General Plan

The Governor's Office of Planning and Research defines a specific plan as "...a tool for the systematic implementation of the general plan." As such, a discussion of the relationship between the Specific Plan and the General Plan is required. This section describes how Specific Plan No. 66 implements various policies and actions of the City of Redlands General Plan.

The Redlands General Plan is a "blueprint" that documents the City's vision for the future and provides goals, policies, and implementation measures that can be utilized by City staff and decision makers to proactively influence physical growth and change in a manner consistent with this vision. The General Plan provides the City with multi-disciplinary strategy for achieving the vision in the context of land use, circulation & mobility, housing, open space, conservation, public safety, noise, cultural resources & historic preservation, growth management, economic development, infrastructure and urban design elements.

The Madera at Citrus Trails community is designed to encourage logical and orderly growth and to consider both existing conditions and future development surrounding the entire property. The property, which is located within and at the eastern boundary of the City, is situated immediately north of the existing Crafton Park and an entrance to the Orange Blossom Trail, and further south of Crafton Park is Crafton Elementary School. New housing and parks on the site adjacent to the existing park, school and trail entrance will result in a walkable and bikable community while taking advantage of and highlighting existing infrastructure already available in the area. The corner features on the northwest and southwest corners of the intersection of Wabash and Colton provide a green gateway entrance for visitors entering Redlands from the east, and welcomes residents to the existing Orange Blossom Trail.

The development also acts as a buffer between the industrial parcels to the east and existing mobile home park and residential developments to the west, and provides the higher density close to the park and school.

Housing in this area of the City allows for the expansion of much needed housing and reduces development pressure on older established neighborhoods. The housing proposed by the specific plan includes a range of housing types and sizes currently

underdeveloped within Redlands: small lot single family homes with ample open space and pedestrian connectivity.

The design of residential neighborhoods and land uses within the specific plan implements the following polices and actions:

2-A.19 Develop entryways and gateways that define Redlands' major points of entry.

4-A.6 Provide for the extension of public services in a logical and functional manner to minimize impacts on service providers while focusing development in infill areas that can accommodate development in a timely manner.

4-P.8 Provide for buffers and transitions between low- and high- intensity land uses.

4-P.10 Ensure that the scale and character of new development is appropriate for surrounding terrain and the character of existing development.

4-P.16 Promote a variety of housing types to serve the diverse needs of the community.

4-A.8 Promote the development of a greater variety of housing types, including single-family homes on small lots, accessory dwelling units, townhomes, lofts, live-work spaces, and senior and student housing to meet the needs of future demographics and changing family sizes.

4-A.49 Ensure that opportunities are available for the development of parks and open space areas to meet the community's recreational needs in a meaningful way.

4-A.50 Ensure that opportunities are available for community-oriented services.

The City of Redlands General Plan Land Use Element (adopted 2017) identifies a vision for future development and land uses in the Specific Plan Area. This Specific Plan is a land use tool to more specifically guide, control, and regulate future development in the Specific Plan area in a manner that implements the land use vision and the goals and policies identified in the General Plan. Exhibit 4, Land Use Plan shows the existing and proposed project site land use designation.

E. General Notes

The following general notes shall apply to all land contained within the Specific Plan boundaries.

1. Any details or issues not specifically addressed by this Specific Plan shall be subject to the regulations of the City of Redlands. Definition of terms shall also be as defined in the codes of the City of Redlands.
2. Water service shall be provided by the City of Redlands.
3. Sewer service shall be provided by the City of Redlands.
4. Electrical power will be provided by the Southern California Edison Company.
5. Natural Gas service will be provided by the Southern California Gas Company.
6. Telephone service will be provided by Verizon.
7. Solid waste disposal will be provided by the City of Redlands.

SECTION 2. MASTER PLANS

A. Land Use

The Specific Plan No. 66, encompasses approximately 9.01 acres accommodating the development of 102 motor court single family homes. In conjunction with the Specific Plan, a General Plan Amendment has been requested to amend the designation of the property from Low Density Residential to Medium Density Residential, permitting 8-15 dwelling units per acre. The Specific Plan has envisioned a somewhat lower density, 102 dwelling units on 9.01 units, for a density of 11.3 dwelling units per acre. The existing and proposed Land Use Plan is depicted in Exhibit 4.

The provision of open space and park land throughout the project site is integral to the design of the community. A project community park is planned for the central portion of the subject development. This park will consist of approximately 27,920 square feet (0.64 acres) and will provide active and passive recreational uses. Included in the park will be a parking lot, picnic areas, tot lot, dog park and other amenities. In addition, a pocket park will be located in the southwest corner of the development. This park will consist of approximately 3,030 square feet (0.07 acres) and will provide an informal decomposed granite path, bench and meadow in the center.

EXHIBIT 4
LAND USE PLAN

B. Circulation Plan

The Circulation Plan is depicted in Exhibit 5, illustrating the vehicular circulation for the subject property. The primary access into the project site will be from Wabash Avenue on the east and Colton Avenue to the south. A system of local private streets will be developed within the project site to provide vehicular access into the motor court neighborhoods. The Typical Street Sections are depicted on Exhibit 6, and described as follows:

- Wabash Avenue - Wabash Avenue will provide the primary vehicular access into the project site. Wabash Avenue adjacent to the project site is currently improved with two travel lanes in each direction. Wabash Avenue is designated a Minor Arterial on the Redlands General Plan with an eighty-eight (88) foot right-of-way and a sixty-four (64) foot street section from curb to curb. Wabash Avenue is currently fully improved adjacent to the project site with paving, curb and gutter and sidewalks.
- Colton Avenue - Colton Avenue is designated as a Minor Arterial on the General Plan, having an eighty-eight (88) foot right-of-way and a sixty-four (64) foot street section from curb to curb. Colton Avenue is currently fully dedicated and improved adjacent to the project site.
- Interior Private Streets - The interior streets servicing the various neighborhoods are planned as private streets, having a thirty-two foot (32) curb to curb section. The interior streets will remain private and maintained by a homeowner's association.
- Motor Court - A private "motor court" will be developed to provide access into the motor court homes within each neighborhood. The motor court will be developed as an alley with a pavement width of twenty-four (24) feet.

EXHIBIT 5
CIRCULATION PLAN

EXHIBIT 5 CIRCULATION PLAN

LEGEND

-  STREET & DRIVE AISLES
-  PEDESTRIAN SIDEWALKS

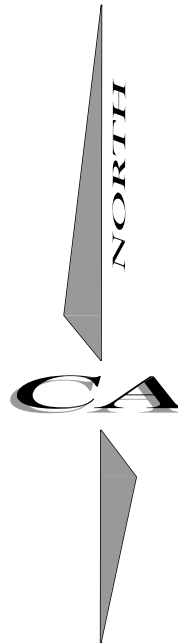

GRAPHIC SCALE

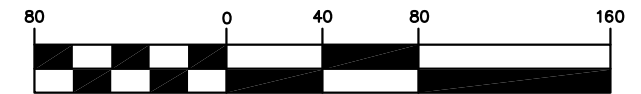

(IN FEET)
1 inch = 80 ft.

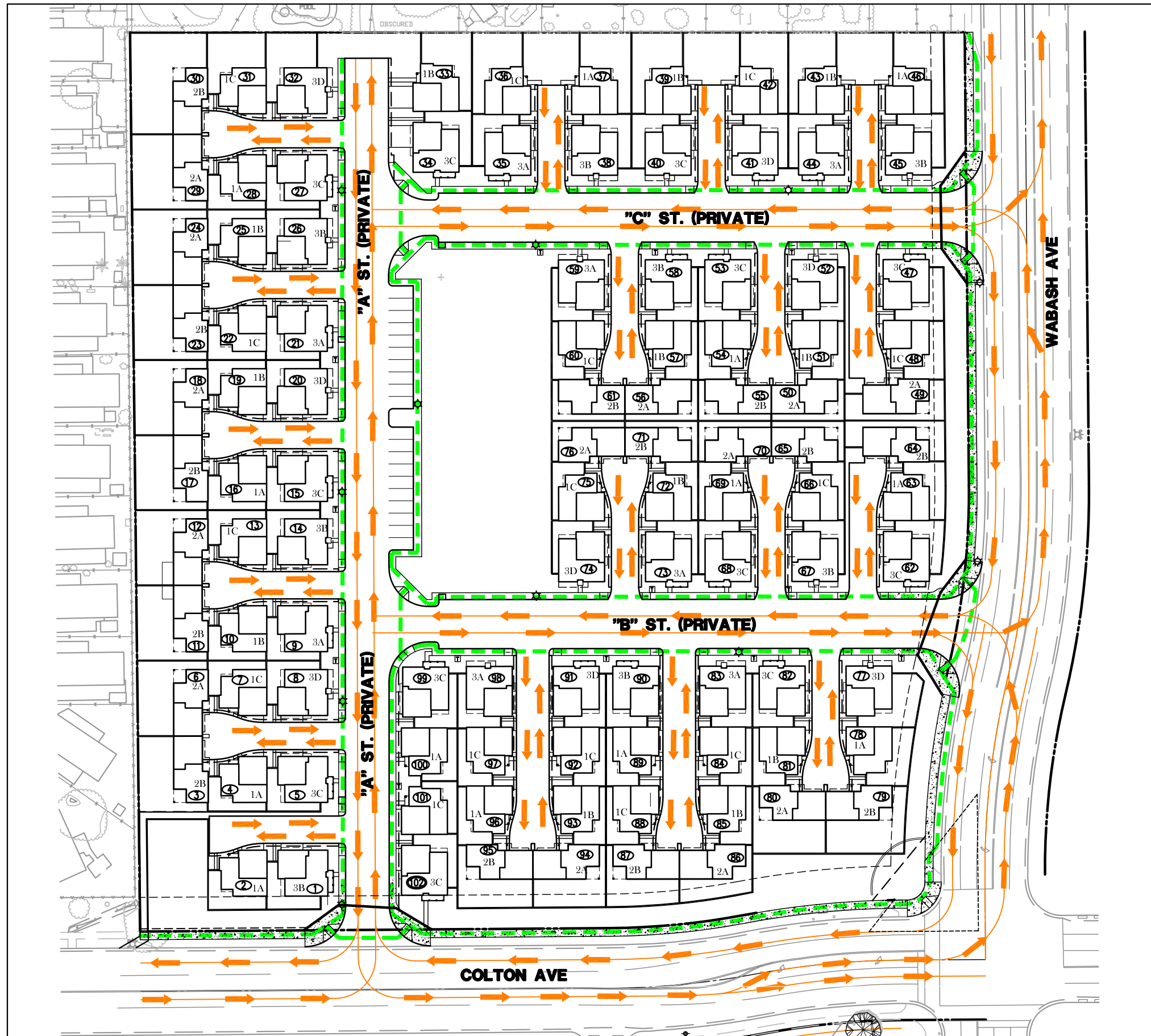

Soni 2012 Irrevocable Trusts

1423 Georgina Avenue Santa Monica
Santa Monica, CA 90402
(949) 922-7075
Contact: Vanita Soni Puri

CA ENGINEERING, INC.

Planning • Engineering • Surveying
13821 NEWPORT AVE., STE 110
TUSTIN, CA 92780
949-724-9480 949-724-9484 FAX

MADERA AT CITRUS TRAIL
SPECIFIC PLAN

EXHIBIT 6
TYPICAL STREET SECTIONS

EXHIBIT 6

TYPICAL STREET SECTIONS

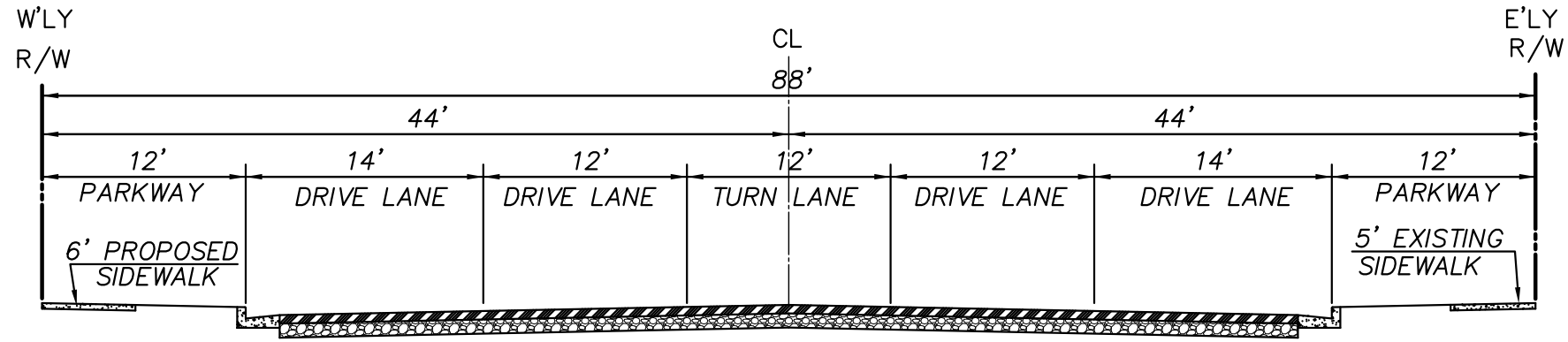

WABASH AVE.
TYPICAL SECTION

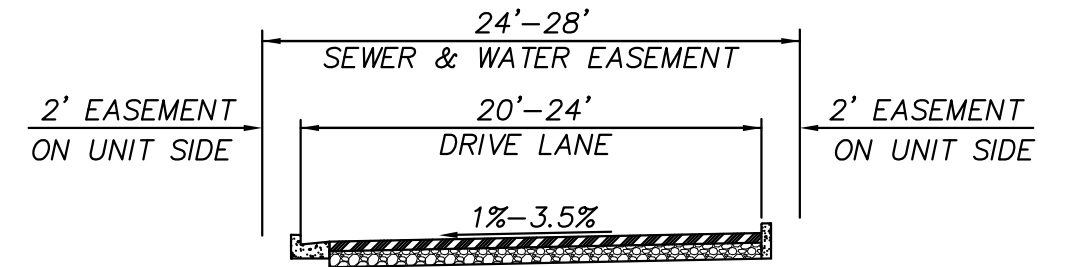

ALLEY
TYPICAL SECTION

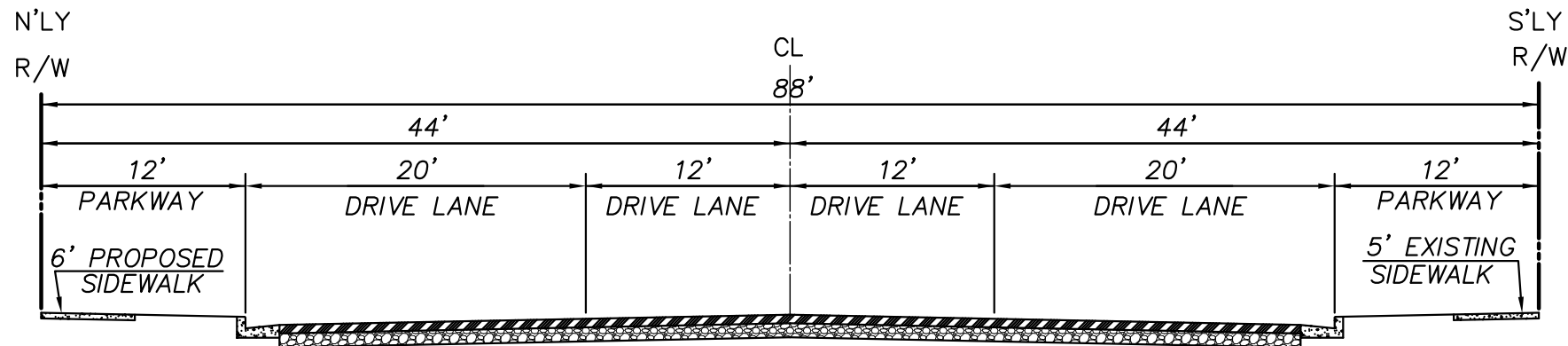

COLTON AVE.
TYPICAL SECTION

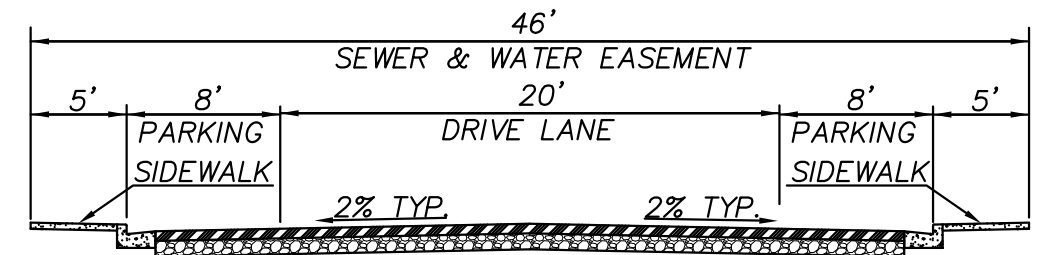

"B" ST. & "C" ST.
TYPICAL SECTION

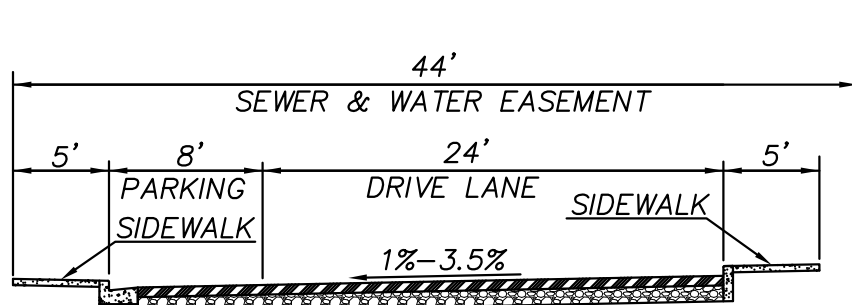

"A" ST. (SECTION 1)
TYPICAL SECTION

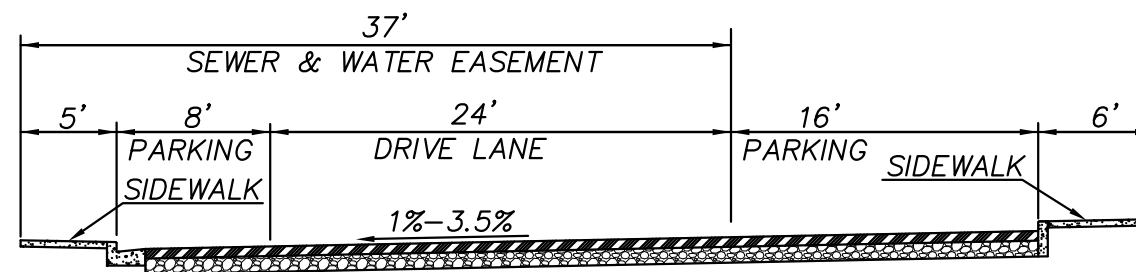

"A" ST. (SECTION 2)
TYPICAL SECTION

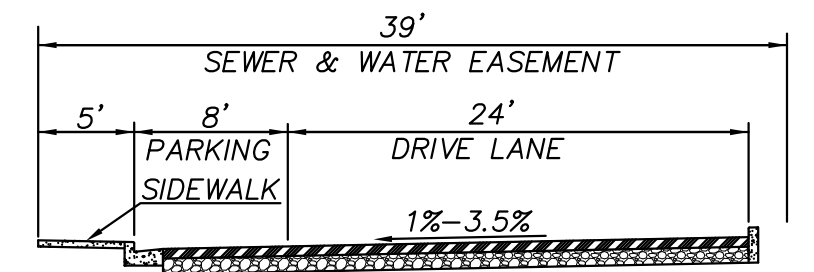

"A" ST. (SECTION 3)
TYPICAL SECTION

C. Infrastructure Plans

The Infrastructure Plans designate the location and size of sewer, water and storm drain lines throughout the project. Private utility lines, including natural gas, electricity, telephone and cable are locally available and are not shown on the plan. The public sewer, water, and storm drain systems will be designed and installed in accordance with plans reviewed and approved by the City of Redlands. The entire storm drain located onsite will be maintained by the homeowners association.

The City of Redlands has established development impact fees that are required to be paid in order to off-set the impact of development upon the City's sewer, water, and storm drain system. The payment of these fees is considered to be adequate mitigation for both the direct and cumulative impact of the project's impact on the City's systems.

1. Water

An existing 20 inch water main is located within Wabash Avenue and an existing 12 inch water main is located within Colton Avenue. A series of eight inch water mains will be constructed within future private streets to provide domestic water service to the project site, connecting to 8 inch water mains within the motor courts to service the dwelling units. The domestic water system will be designed and installed pursuant to City of Redlands standards, and appropriate easements will be dedicated to the City. The Domestic Water Plan is depicted on Exhibit 7.

2. Sewer

An existing 8 inch sewer line is located in Colton Avenue adjacent to the project site. This sewer line conveys wastewater westerly under the 1-210 Freeway to the City of Redlands' Wastewater Treatment Facility. Within the project site, a series of eight inch sewer lines will be constructed within the private streets looping through the various neighborhoods. In addition, 8 inch sewer lines will be constructed within the motor courts to service individual dwelling units. The sewer system will be designed and installed pursuant to City of Redlands standards, and appropriate easements will be dedicated to the City. The Conceptual Sanitary Sewer Plan is depicted in Exhibit 8.

3. Storm Drainage

The Conceptual Drainage Plan is depicted in Exhibit 9. Currently, project site is unimproved and existing runoff flows northerly and westerly via sheet flow, eventually flowing into the existing storm drain to the west within Colton Avenue. Existing drainage patterns will be modified to conduct storm water





appropriately.

All lots will be graded to allow runoff to drain towards a designated street or area drain, leading to the proposed storm drain infrastructure. Grate inlets, curb and gutters and storm drain pipes appropriately sized will be utilized to collect the runoff and direct it to the infiltration basins located within the park and at the most southwesterly corner of the project. All storm drains in the project will be maintained by the community via a homeowners association. When the infiltration basins fill, the excess storm flows will be conveyed to a drainage channel that will be connected to Colton Ave. via a parkway culvert.

EXHIBIT 7
DOMESTIC WATER PLAN

EXHIBIT 7 DOMESTIC WATER PLAN

LEGEND

-  PROPOSED DOMESTIC WATERLINE
-  PROPOSED FIRE HYDRANT
-  EXISTING DOMESTIC WATERLINE
-  EXISTING FIRE HYDRANT

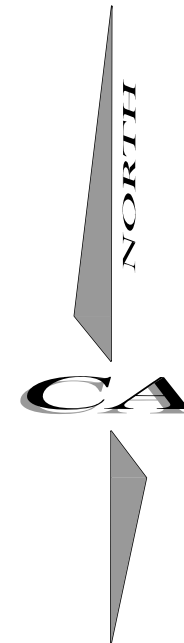

GRAPHIC SCALE



(IN FEET)
1 inch = 80 ft.



Soni 2012 Irrevocable Trusts

1423 Georgina Avenue Santa Monica
Santa Monica, CA 90402
(949) 922-7075
Contact: Vanita Soni Puri

CA ENGINEERING, INC.





Planning • Engineering • Surveying
13821 NEWPORT AVE., STE 110
TUSTIN, CA 92780
949-724-9480 949-724-9484 FAX

MADERA AT CITRUS TRAIL
SPECIFIC PLAN

EXHIBIT 8
SANITARY SEWER PLAN

EXHIBIT 8 SANITARY SEWER SYSTEM

LEGEND

-  PROPOSED SEWER SYSTEM
-  PROPOSED MANHOLE
-  EXISTING SEWER SYSTEM
-  EXISTING MANHOLE

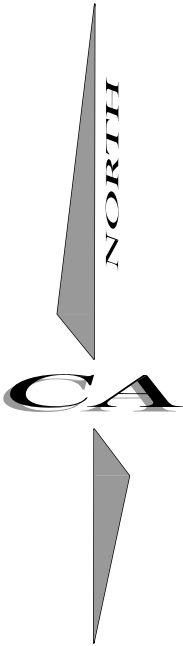

GRAPHIC SCALE

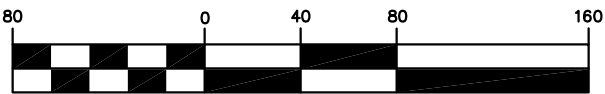

(IN FEET)
1 inch = 80 ft.

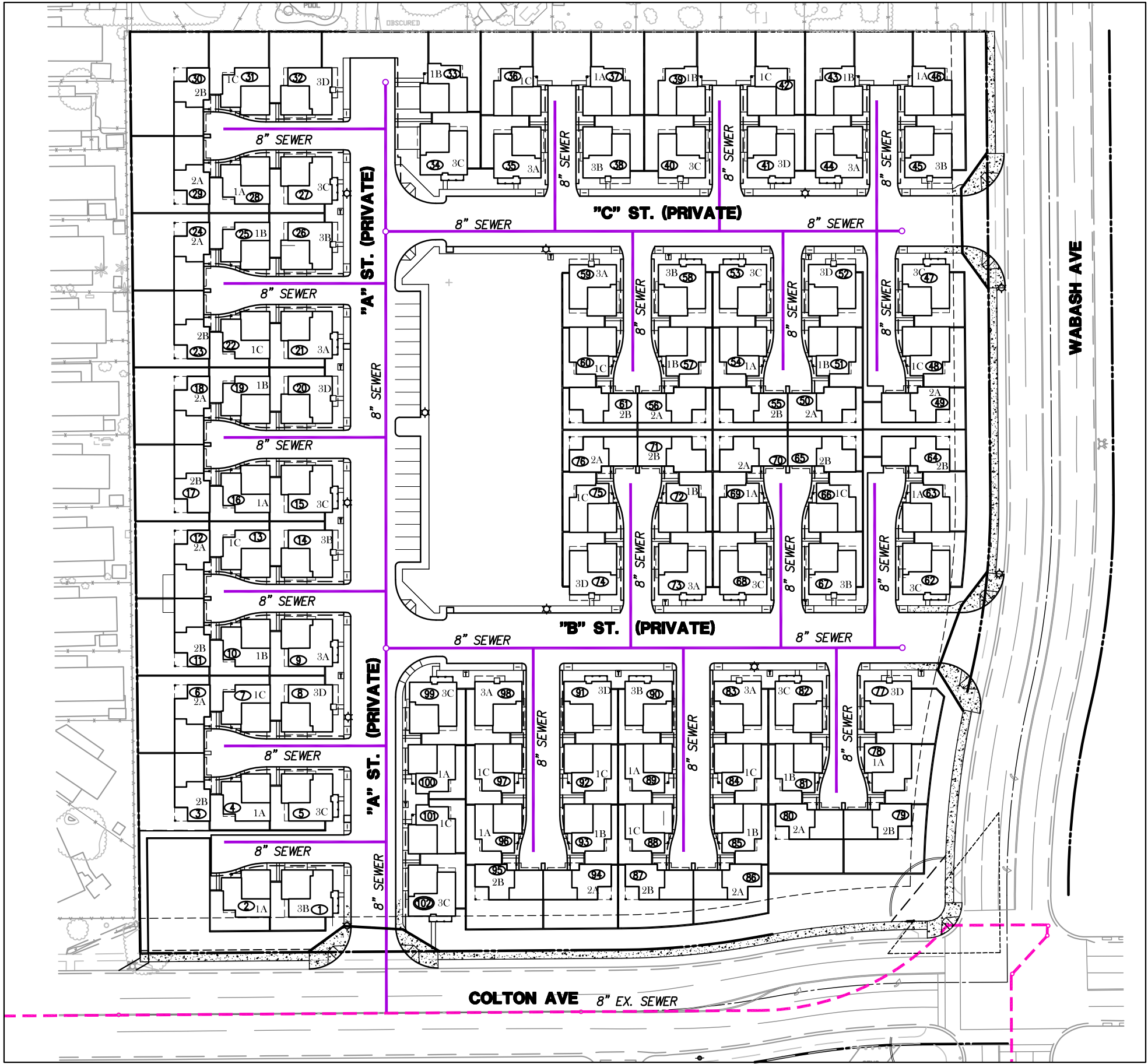

Soni 2012 Irrevocable Trusts
1423 Georgina Avenue Santa Monica
Santa Monica, CA 90402
(949) 922-7075
Contact: Vanita Soni Puri



CA ENGINEERING, INC.
Planning • Engineering • Surveying
13821 NEWPORT AVE., STE 110
TUSTIN, CA 92780
949-724-9480 949-724-9484 FAX

MADERA AT CITRUS TRAIL
SPECIFIC PLAN

EXHIBIT 9
DRAINAGE PLAN

EXHIBIT 9 DRAINAGE PLAN

LEGEND

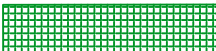
-  PROPOSED STORM DRAIN
-  PROPOSED CATCH BASIN
-  PROPOSED WQMP DEVICES

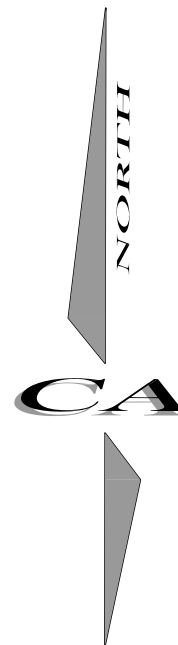

GRAPHIC SCALE



(IN FEET)
1 inch = 80 ft.



Soni 2012 Irrevocable Trusts

1423 Georgina Avenue Santa Monica
Santa Monica, CA 90402
(949) 922-7075
Contact: Vanita Soni Puri

CA ENGINEERING, INC.

Planning • Engineering • Surveying
13821 NEWPORT AVE., STE 110
TUSTIN, CA 92780
949-724-9480 949-724-9484 FAX

MADERA AT CITRUS TRAIL
SPECIFIC PLAN

D. Conceptual Landscape Plan

The Conceptual Landscape Plan is illustrated in Exhibit 10. The landscape and open space treatment for the project is important for the overall beauty and neighborhood enjoyment for the future residents. The landscape design incorporates a large central park with amenities, attractive streetscapes, and corner monumentation at the northwest and southwest intersections of Wabash Avenue and Colton Avenue.

Exhibit 11 depicts the Community Park and amenity details. As depicted, the community park will include a tot lot with climb-n-slide equipment, spinning play, enclosed dog park, open play turf area, matching steel shade structure, solid roof "farm house" structure with table seating below, outdoor kitchen with grills and counter top seating, and grove in raised planter. Exhibits 11.1 and 11.2 depict scenes of the community park.

Exhibit 12 depicts the typical motor court design. The motor court will include small strategic planters for trees and shrubs.

Exhibit 13 depicts the private yard areas within the motor courts and Exhibit 13.1 depicts an enlarged motor court scene.

A Fence and Wall Plan is illustrated in Exhibit 14. Fencing will consist of a variety of decorative block walls, vinyl fencing and tubular steel fencing.

EXHIBIT 10
CONCEPTUAL LANDSCAPE PLAN

PLANT LIST

SYMBOL	BOTANICAL NAME	COMMON NAME	WUCOLS (Zone 3)	SIZE	QTY
TREES					
	Acacia stenophylla	Shoestring Acacia	L	24" Box	68
	Magnolia grandiflora 'Alta'	Southern Magnolia	M	24" Box	
	Cercidium hyb. 'Desert Museum'	Hybrid Palo Verde	L	24" Box	8
	Arbutus 'Marina'	Strawberry Tree	L	24" Box	83
	Bauhinia purpurea	Orchid Tree	M	24" Box	
	Lagerstroemia hybrids 'Natchez'	Crape Myrtle (White)	M	24" Box	
	Cupressus sempervirens 'Monshel'	Tiny Tower Cypress	L	24" Box	12
	Strelitzia nicholai	Giant Bird-of-Paradise	M	24" Box	
	Cedrus deodara	Deodar Cedar	L	24" Box	14
	Citrus sinensis	Orange Trees	M	24" Box	13
	Geijera parviflora	Australian Willow	L	24" Box	10
	Jacaranda mimosifolia	Jacaranda	M	36" Box	12
	Schinus molle	California Pepper Tree	L	36" Box	16
	Ulmus parvifolia 'True Green'	Evergreen Elm	M	24" Box	25
PALMS					
	Phoenix dactylifera	Date Palm	L	16" BTH	26
	Washingtonia robusta	Mexican Fan Palm	L	24" Box	
	Brahea armata	Mexican Blue Palm	L	24" Box	24
	Syagrus romanzoffianum	Queen Palm	M	24" Box	27
SHRUBS					
	Agave 'Blue Flame'	Blue Flame Agave	L	5G	100
	Agave douglasiana 'Variegata'	Dwarf Century Plant	L	5G	120
	Aloe arborescens	Tree Aloe	L	15G	30
	Bougainvillea 'La Jolla'	Bougainvillea	L	5G	50
	Buxus microphylla japonica	Japanese Boxwood	M	1G	1,100
	Carex divulsa	Berkeley Sedge	L	5G	1,000
	Carissa grandiflora 'Green Carpet'	Natal Plum	L	1G	450
	Chondropetalum tectorum	Cape Rush	L	5G	120
	Cordyline australis 'Red Star'	Red Grass Palm	L	15G	20
	Dianella revoluta 'DR5000'	Little Rev Flax Lily	M	1G	300
	Dianella tasmanica 'Silver Streak'	Silver Streak Flax Lily	M	5G	400
	Eesperale parviflora	Red Yucca	L	5G	20
	Ilex crenata 'Sky Pencil'	Sky Pencil Ilex	M	15G	50
	Juniperus scopulorum 'Skyrocket'	Skyrocket Juniper	M	15G	40
	Lantana hybrids 'New Gold'	New Gold Lantana	L	5G	30
	Ligustrum japonicum 'Texanum'	Wax Leaf Privet	M	5G	700
	Miscanthus sinensis 'Strictus'	Porcupine Grass	M	5G	40
	Olea europaea 'Montra' P.P.#6266	Little Ollie Dwarf Olive	L	5G	300
	Podocarpus elongatus 'Monmal'	Icee Blue Yellow-Wood	M	15G	100
	Rhampholepis indica 'Clara'	Dwarf Indian Hawthorne	M	5G	300
	Rosa f. 'Trumpeter'	Trumpeter Rose	M	5G	150
	Senecio mandraliscae	Blue Chalk Sticks	L	Root Cut	400
	Stipa tenuissima	Mexican Feather Grass	L	5G	120
	Tecoma stans 'Sierra Apricot'	Sierra Apricot	L	5G	40
	Trachelospermum jasminoides	Star Jasmine	M	5G	56
	Westringia 'Wynabbie Gem'	Coast Rosemary	L	5G	56
	Yucca gloriosa	Spanish Dagger	L	5G	10
	Yucca recurvifolia	Pendulous Yucca	L	5G	10

LEGEND

- ① COMMUNITY PARK
 - TOT LOT
 - DOG PARK
 - BBQ AREA
 - VINE COVERED SHADE STRUCTURE
- ② COMMON AREA LANDSCAPE (TYP.)
- ③ PRIVATE OPEN SPACE (TYP.)
- ④ MOTOR COURT (SEE SHEET L2 FOR ENLARGEMENT)
- ⑤ COMMUNITY MONUMENTATION
- ⑥ ENTRANCE TO "ORANGE-BLOSSOM TRAIL"
- ⑦ OPEN SPACE W/ INFORMAL DG PATH, BENCH AND MEADOW IN THE CENTER



CONCEPTUAL LANDSCAPE PLAN



Soni 2012 Irrevocable Trusts
 1423 Georgina Avenue Santa Monica
 Santa Monica, CA 90402
 (949) 922-7075
 Contact: Vanita Soni Puri

CA ENGINEERING, INC.
 Planning • Engineering • Surveying
 13821 NEWPORT AVE., STE 110
 TUSTIN, CA 92780
 949-724-9480 949-724-9484 FAX



SITE SCAPE
 Landscape Architecture & Planning
 3190-B2 Airport Loop Drive
 Costa Mesa, CA 92626
 Robert Polovina, Licensed # 3782
 (949) 644-9370 FAX (714) 210-3140
 JOB# 22-026 DATE: 12-12-23

MADERA AT CITRUS TRAIL
 SPECIFIC PLAN

EXHIBIT 11
COMMUNITY PARK PLAN



- LEGEND**
- ① TOT LOT WITH CLIMB-N-SLIDE EQUIPMENT
 - ② SPINNING PLAY
 - ③ ENCLOSED DOG PARK W/ DRINKING FOUNTAIN
 - ④ OPEN PLAY TURF
 - ⑤ MATCHING STEEL SHADE STRUCTURE
 - ⑥ SOLID ROOF "FARM HOUSE" STRUCTURE W/ TABLE SEATING BELOW
 - ⑦ OUTDOOR KITCHEN W/ (2) GRILLS AND COUNTER TOP SEATING
 - ⑧ GROOVE IN RAISED PLANTER

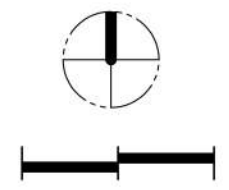

COMMUNITY PARK ENLARGEMENT



Soni 2012 Irrevocable Trusts
 1423 Georgina Avenue Santa Monica
 Santa Monica, CA 90402
 (949) 922-7075
 Contact: Vanita Soni Puri

CA ENGINEERING, INC.
 Planning • Engineering • Surveying
 13821 NEWPORT AVE., STE 110
 TUSTIN, CA 92780
 949-724-9480 949-724-9484 FAX



SITECAPE
 Landscape Architecture & Planning
 3190-B2 Airport Loop Drive
 Costa Mesa, CA 92626
 Richard Polhemus, Licensed P 3782
 (949) 644-9370 FAX (714) 210-3140
 JOB# 22-026 DATE: 12-12-23

MADERA AT CITRUS TRAIL
 SPECIFIC PLAN

EXHIBIT 11.1

COMMUNITY PARK SCENE



Soni 2012 Irrevocable Trusts

1423 Georgia Avenue Santa Monica
 Santa Monica, CA 90402
 (849) 822-7075
 Contact: Vanita Soni Puri

CA ENGINEERING, INC.

Planning • Engineering • Surveying
 13821 NEWPORT AVE., STE 110
 TUSTIN, CA 92780
 949-724-9480 949-724-9484 FAX



SITE SCAPES

Landscape Architecture & Planning
 5190-82 Airport Loop Drive
 Costa Mesa, CA 92626
 Richard Fohmanus, License # 2782
 (949) 644-9370 FAX (714) 210-3140

**MADERA AT CITRUS TRAIL
 SPECIFIC PLAN**

EXHIBIT 11.2

COMMUNITY PARK SCENE



Soni 2012 Irrevocable Trusts

1423 Georgina Avenue Santa Monica
 Santa Monica, CA 90402
 (849) 922-7075
 Contact: Vanita Soni Puri

CA ENGINEERING, INC.

Planning • Engineering • Surveying
 13821 NEWPORT AVE., STE 110
 TUSTIN, CA 92780
 949-724-9480 949-724-9484 FAX



SITE ESCAPE

Landscape Architecture & Planning
 5190-82 Airport Loop Drive
 Costa Mesa, CA 92626
 Richard Polshus, License # 2782
 (949) 644-9370 FAX (714) 210-3140

**MADERA AT CITRUS TRAIL
 SPECIFIC PLAN**

EXHIBIT 12

TYPICAL MOTOR COURT PLAN

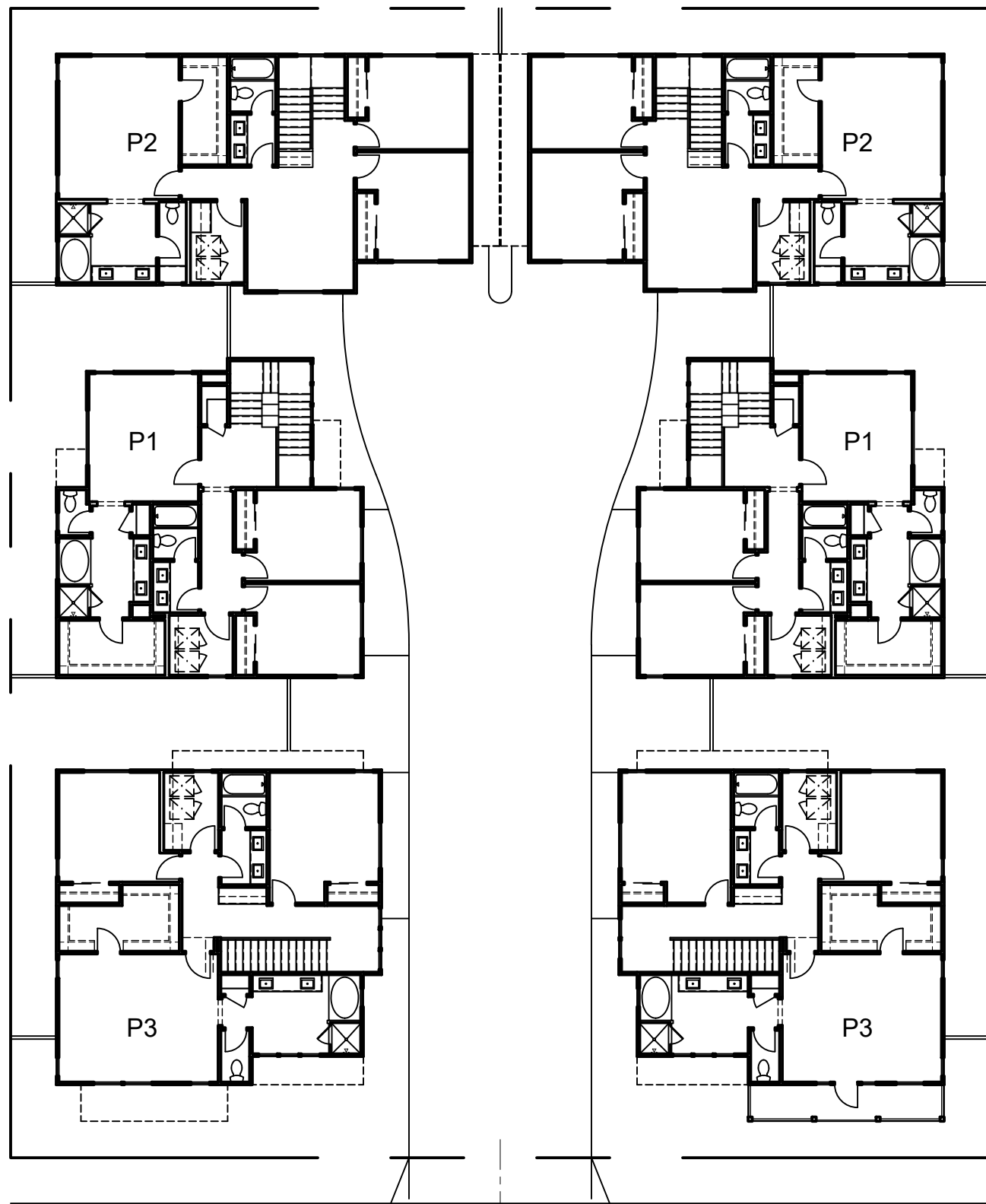

Second Floor



First Floor

Scale: 1/16" = 1'-0"

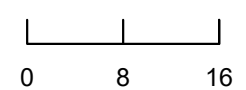

Soni 2012 Irrevocable Trusts

1423 Georgina Avenue Santa Monica
 Santa Monica, CA 90402
 (848) 922-7075
 Contact: Vanita Soni Puri

CA ENGINEERING, INC.

Planning • Engineering • Surveying
 13821 NEWPORT AVE., STE 110
 TUSTIN, CA 92780
 949-724-9480 949-724-9484 FAX



SITE SCAPES
 Landscape Architecture & Planning

3190-82 Airport Loop Drive
 Costa Mesa, CA 92626
 Richard Pothman, License # 2782
 (949) 444-9370 FAX (714) 210-3140

MADERA AT CITRUS TRAIL
 SPECIFIC PLAN

EXHIBIT 13

MOTOR COURT ENLARGEMENT

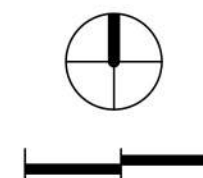

MOTOR COURT ENLARGEMENT



<p>Soni 2012 Irrevocable Trusts 1423 Georgina Avenue Santa Monica Santa Monica, CA 90402 (949) 922-7075 Contact: Vanita Soni Puri</p>	<p>CA ENGINEERING, INC. Planning • Engineering • Surveying 13821 NEWPORT AVE., STE 110 TUSTIN, CA 92780 949-724-9480 949-724-9484 FAX</p>
--	---



MADERA AT CITRUS TRAIL
 SPECIFIC PLAN

EXHIBIT 13.1

MOTOR COURT SCENE



Soni 2012 Irrevocable Trusts

1423 Georgina Avenue Santa Monica
 Santa Monica, CA 90402
 (848) 822-7075
 Contact: Vanita Soni Puri

CA ENGINEERING, INC.

Planning • Engineering • Surveying
 13821 NEWPORT AVE., STE 110
 TUSTIN, CA 92780
 949-724-9480 949-724-9484 FAX



SITE ESCAPE
 Landscape Architecture & Planning

3190-B2 Airport Loop Drive
 Costa Mesa, CA 92626
 Richard Fohmanus, License # 2782
 (949) 644-9370 FAX (714) 210-3140

**MADERA AT CITRUS TRAIL
 SPECIFIC PLAN**

EXHIBIT 14
FENCE AND WALL PLAN

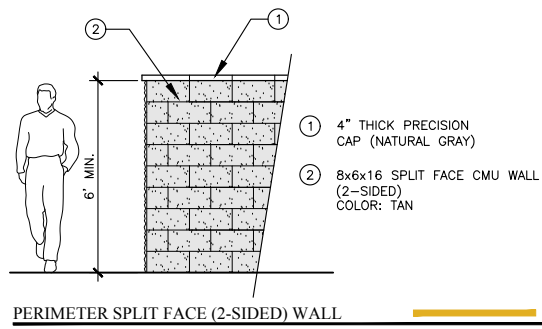

PERIMETER SPLIT FACE (2-SIDED) WALL

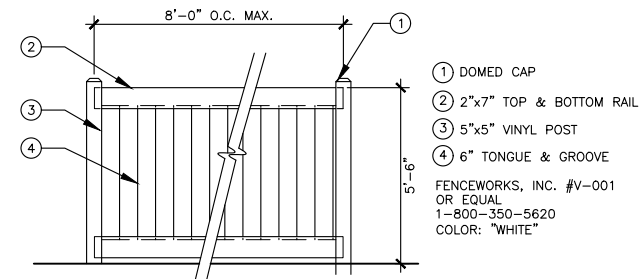

PRIVACY VINYL FENCE

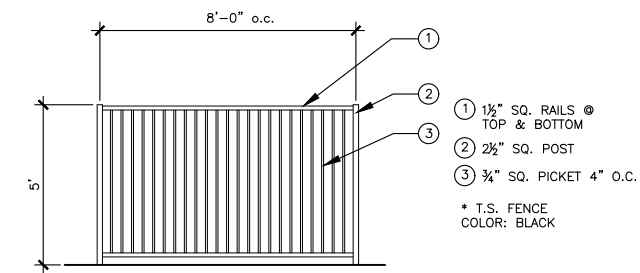

TUBULAR STEEL FENCE

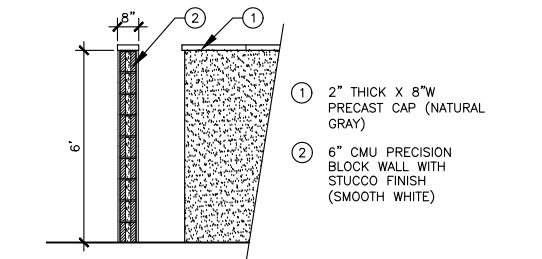

PRIVACY STUCCO WALL

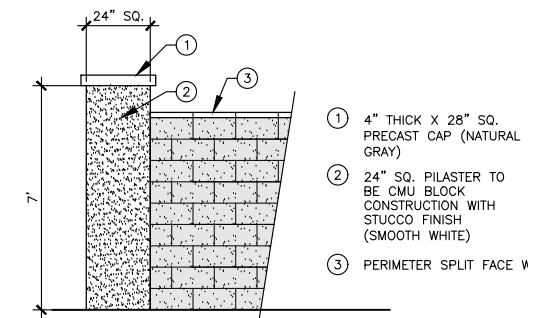

24" SQ. PERIMETER STUCCO PILASTER



OVERALL FENCE & WALL PLAN



Soni 2012 Irrevocable Trusts

1423 Georgina Avenue Santa Monica
Santa Monica, CA 90402
(949) 922-7075
Contact: Vanita Soni Puri

CA ENGINEERING, INC.

Planning • Engineering • Surveying
13821 NEWPORT AVE, STE 110
TUSTIN, CA 92780
949-724-9480 949-724-9484 FAX



SITECAPE
Landscape Architecture & Planning

3190-B2 Airport Loop Drive
Costa Mesa, CA 92626
Richard Robinson, Licensed P 2782
(949) 644-9370 FAX (714) 210-3140
JOB# 22-026 DATE: 12-12-23

MADERA AT CITRUS TRAIL
SPECIFIC PLAN

E. Conceptual Architecture

The architectural design and site planning of the homes within the project is important to create the sense of the nee-traditional design of the neighborhoods. Redlands is well known for its eclectic mix of architectural styles and themes, and the conceptual architecture will include styles of Farmhouse, Ranch, Mediterranean and Spanish, and Monterey. This combination will provide for a variety of styles creating aesthetic streetscapes and housing choices.

Madera at Citrus Trails has been designed as a "motor court" neighborhood consisting of 102 single-family dwelling units as depicted on Exhibit 15, Conceptual Plotting Plan. The units will be serviced by an alley system or motor court. Three different floor plans will be provided, consisting of two-story homes ranging in size from 1,544 square feet to 1,858 square feet. Exhibits 16, 17 and 18 depict conceptual floor plans.

Architectural styles are depicted in Exhibit 19, and described as follows:

- Style "A" draws from Mediterranean and Spanish influences - seen with the inclusion of corbels, exterior plaster surround, enhanced window trim style, and includes a monochrome color scheme with a notable pot shelf with kickers. Style "A" salutes its Spanish Mediterranean feel with muted monochromatic tones, Spanish roof tiles and trim wainscot band.
- Style "B" - The frequently desired Farmhouse style showcases a variety of textures including Board and Batten and Lap siding alluding to typical Farmhouse architectural features. Additionally, metal roofing was chosen on the lower roof segments, creating diversity from the other styles. Style "B" features color schemes of high contrast of cool and neutral colors adding further variation to the site.
- Style "C" depicts a Monterey style most notable by the Monterey balcony and steeper roof pitches with the use of slate tile. Incorporating cool, light and airy schemes gestures to a Monterey feel. The front elevation is enhanced with the inclusion of shutters and thin stacked brick while the lap siding and shutters included in the architectural details heightens the side and rear elevation design. Style "C" includes a monochrome color scheme with a notable accent color to add interest and complexity to the style.
- Style "D" delineates a modern Ranch architectural style which also incorporates a balcony with double French doors enhancing the front elevations. Shutters and lap siding details combined with accent color blocking help create visual interest on the other elevations for both color schemes.

A series of perspectives and renderings has been created to elaborate on the attention to detail and design elements of the Madera at Citrus Trail project. These exhibits are as follows:

Exhibit 20 – Interior Streetscape Scene

Exhibit 21 – Community Edge Enhancements (Wabash Avenue)



Exhibit 22 – Community Edge Enhancements (Colton Avenue)

EXHIBIT 15
CONCEPTUAL PLOTTING

EXHIBIT 14

CONCEPTUAL PLOTTING

LEGEND

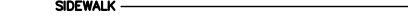
BOUNDARY LINE 
 PROP. CURB 
 SIDEWALK 

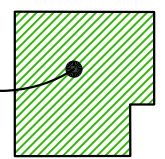
"A" ELEVATION

 LIMITS OF PRIVATE OWNERSHIP

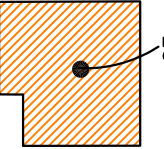
"B" ELEVATION

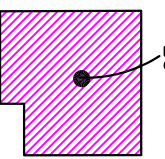
 LIMITS OF PRIVATE OWNERSHIP

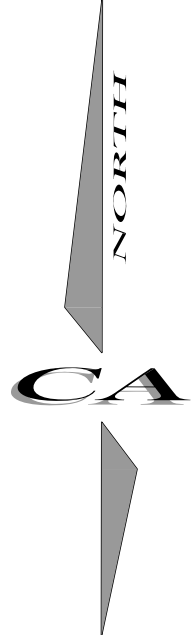
"C" ELEVATION

 LIMITS OF PRIVATE OWNERSHIP

"D" ELEVATION

 LIMITS OF PRIVATE OWNERSHIP



GRAPHIC SCALE



(IN FEET)
 1 inch = 80 ft.



Soni 2012 Irrevocable Trusts
 1423 Georgina Avenue Santa Monica
 Santa Monica, CA 90402
 (949) 922-7075
 Contact: Vanita Soni Puri

CA ENGINEERING, INC.
 Planning · Engineering · Surveying
 13821 NEWPORT AVE., STE 110
 TUSTIN, CA 92780
 949-724-9480 949-724-9484 FAX

MADERA AT CITRUS TRAIL
 SPECIFIC PLAN

EXHIBIT 16

CONCEPTUAL FLOOR PLAN – PLAN 1

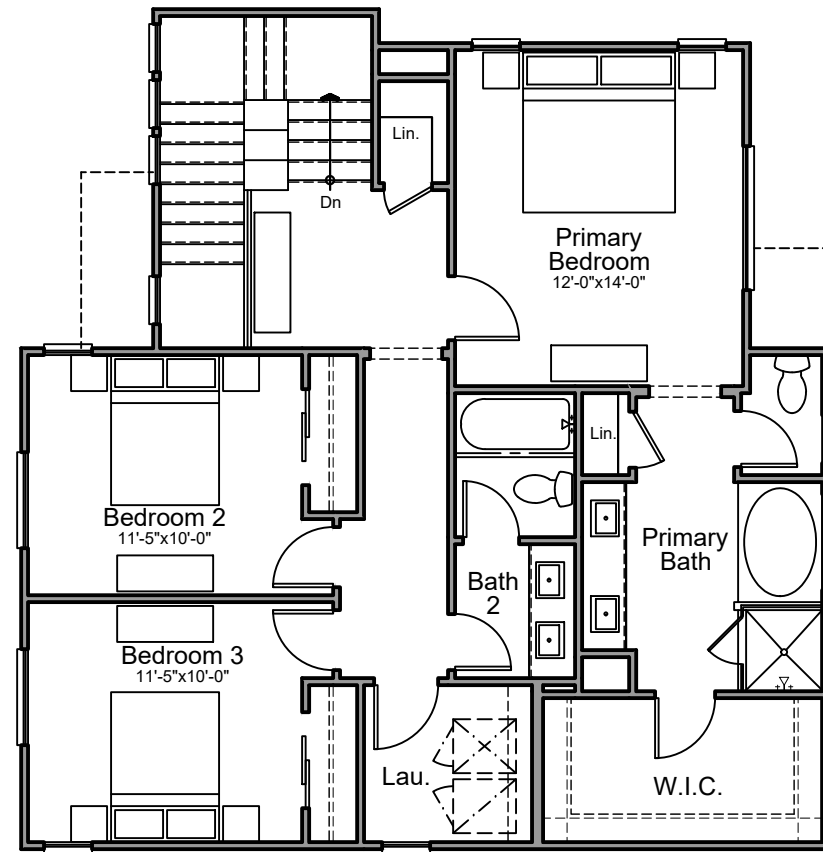

Second Floor

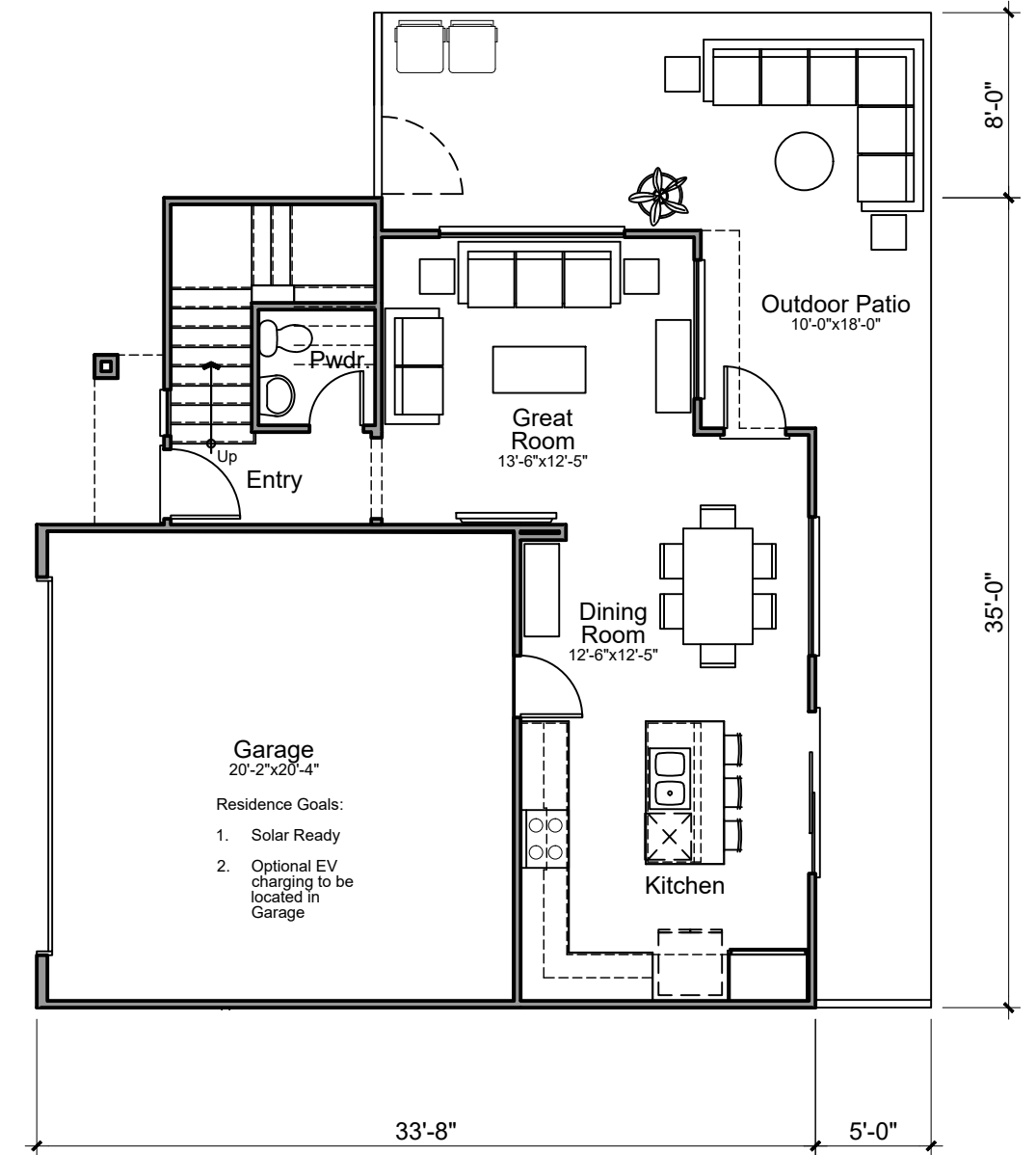

First Floor

PLAN 1 (3 BED / 2.5 BATH)	
FIRST FLOOR	606 SQ. FT.
SECOND FLOOR	938 SQ. FT.
TOTAL	1,544 SQ. FT.



Soni 2012 Irrevocable Trusts
 1423 Georgina Avenue Santa Monica
 Santa Monica, CA 90402
 (848) 922-7075
 Contact: Vanita Soni Puri

CA ENGINEERING, INC.
 Planning • Engineering • Surveying
 13821 NEWPORT AVE., STE 110
 TUSTIN, CA 92780
 949-724-9480 949-724-9484 FAX



SITE ESCAPES
 Landscape Architecture & Planning
 3190-82 Airport Loop Drive
 Costa Mesa, CA 92626
 Richard Fishman, License # 2782
 (949) 644-9370 FAX (714) 210-3140

Scale: 1/8" = 1'-0"

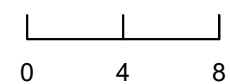

MADERA AT CITRUS TRAIL
 SPECIFIC PLAN

EXHIBIT 17

CONCEPTUAL FLOOR PLAN – PLAN 2

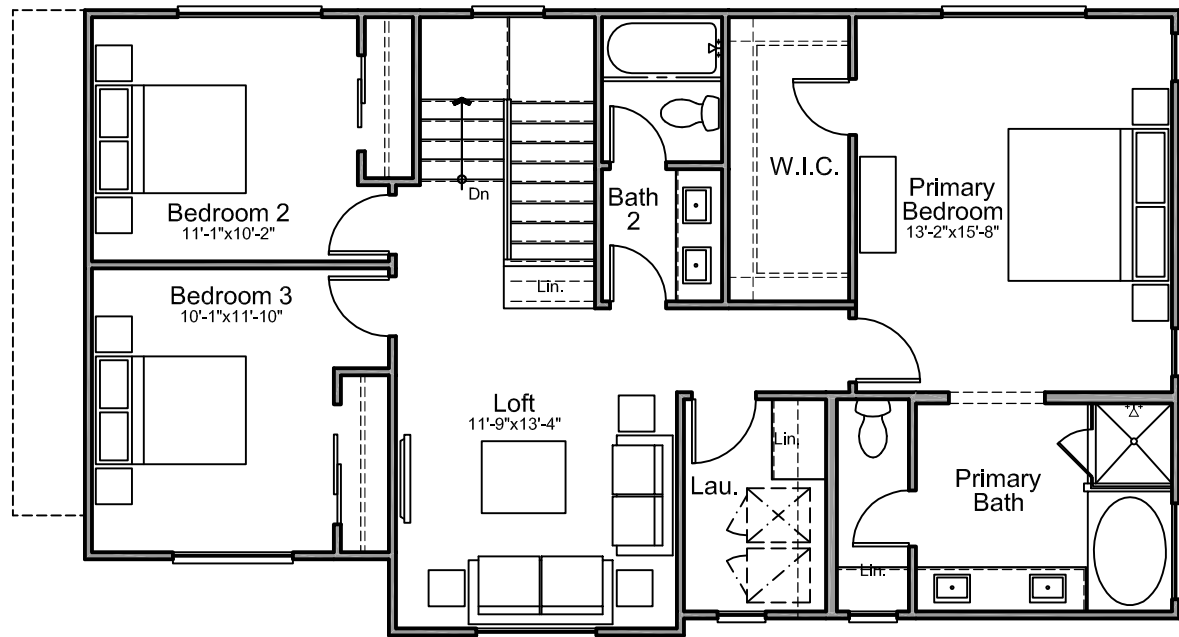

Second Floor

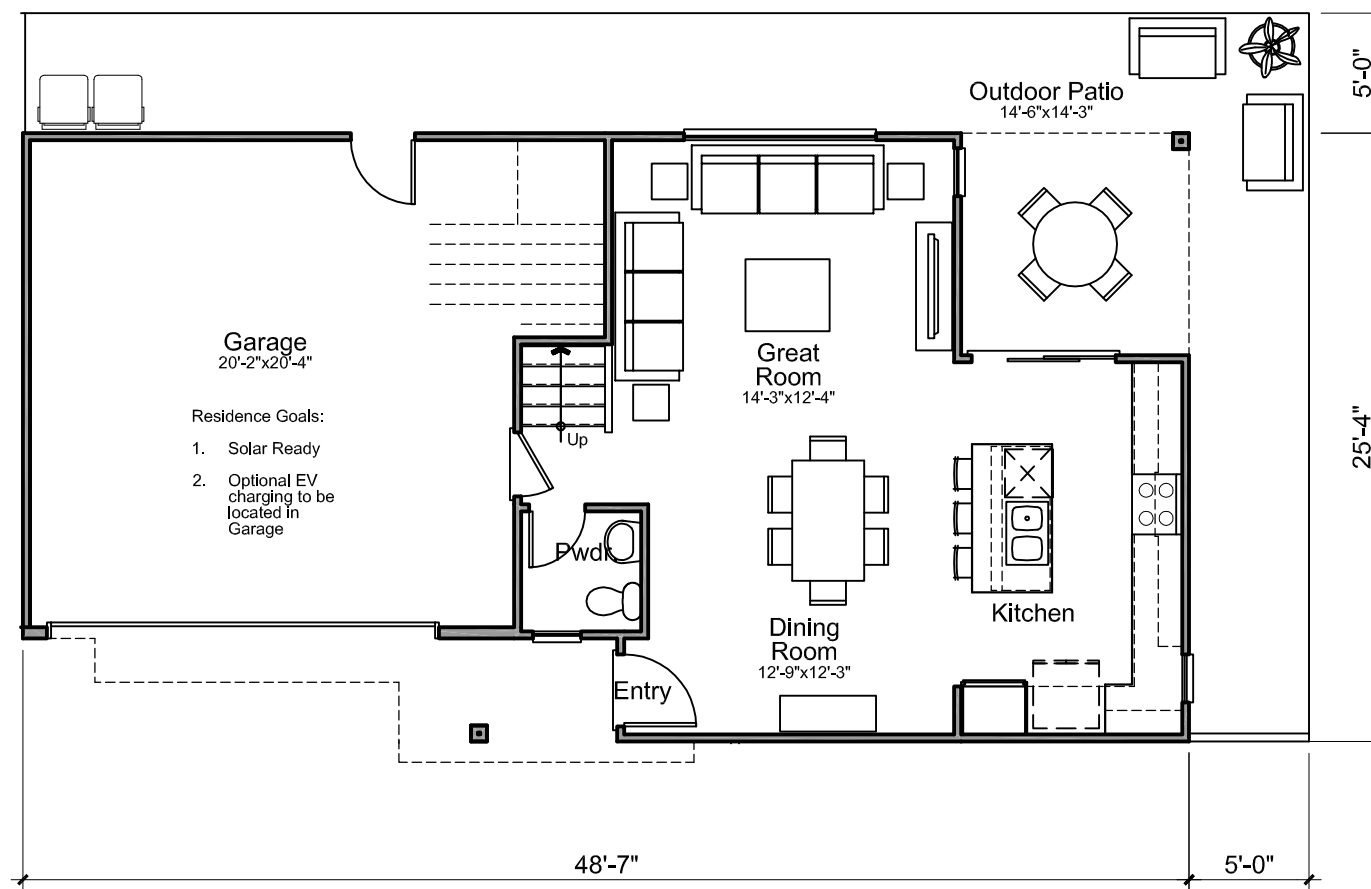

First Floor

PLAN 2 (3 BED / 2.5 BATH)	
FIRST FLOOR	631 SQ. FT.
SECOND FLOOR	1069 SQ. FT.
TOTAL	1,700 SQ. FT.



Soni 2012 Irrevocable Trusts
 1423 Georgina Avenue Santa Monica
 Santa Monica, CA 90402
 (849) 922-7075
 Contact: Vanita Soni Puri

CA ENGINEERING, INC.
 Planning • Engineering • Surveying
 13821 NEWPORT AVE., STE 110
 TUSTIN, CA 92780
 949-724-9480 949-724-9484 FAX



SITE SCAPES
 Landscape Architecture & Planning
 3190-B2 Airport Loop Drive
 Costa Mesa, CA 92626
 Richard Fulkerson, License # 2782
 (949) 644-9370 FAX (714) 210-3140

Scale: 1/8" = 1'-0"



MADERA AT CITRUS TRAIL
 SPECIFIC PLAN

EXHIBIT 18

CONCEPTUAL FLOOR PLAN – PLAN 3

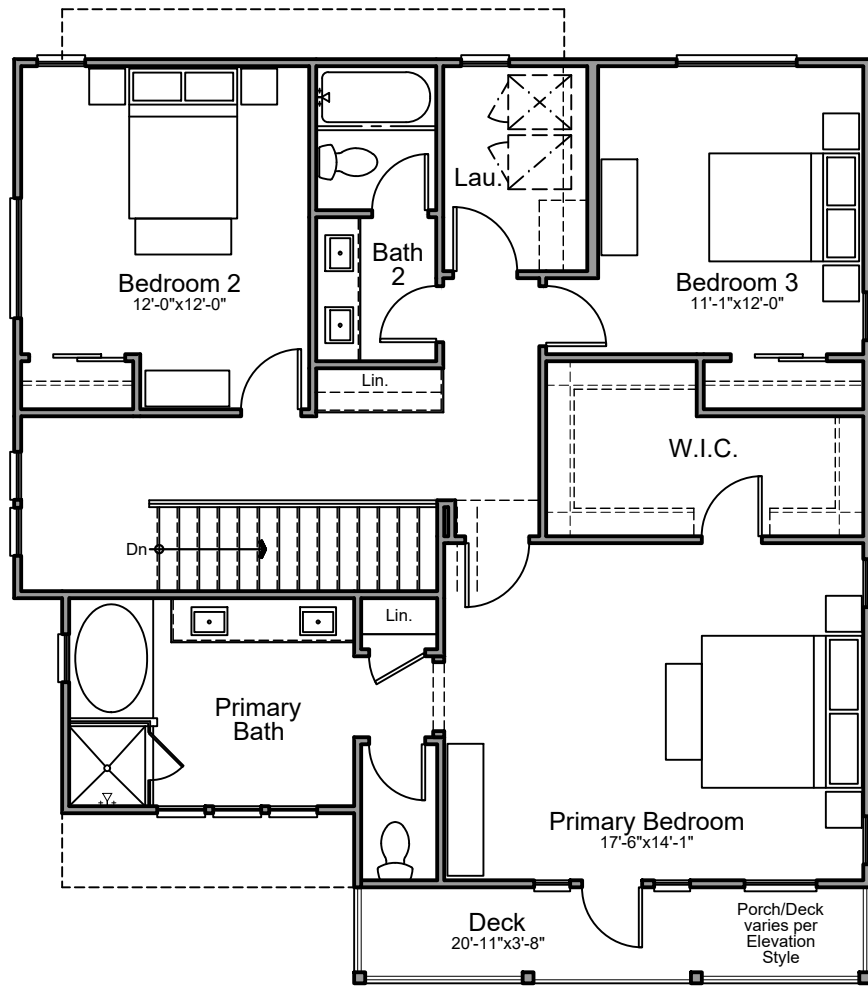

Second Floor

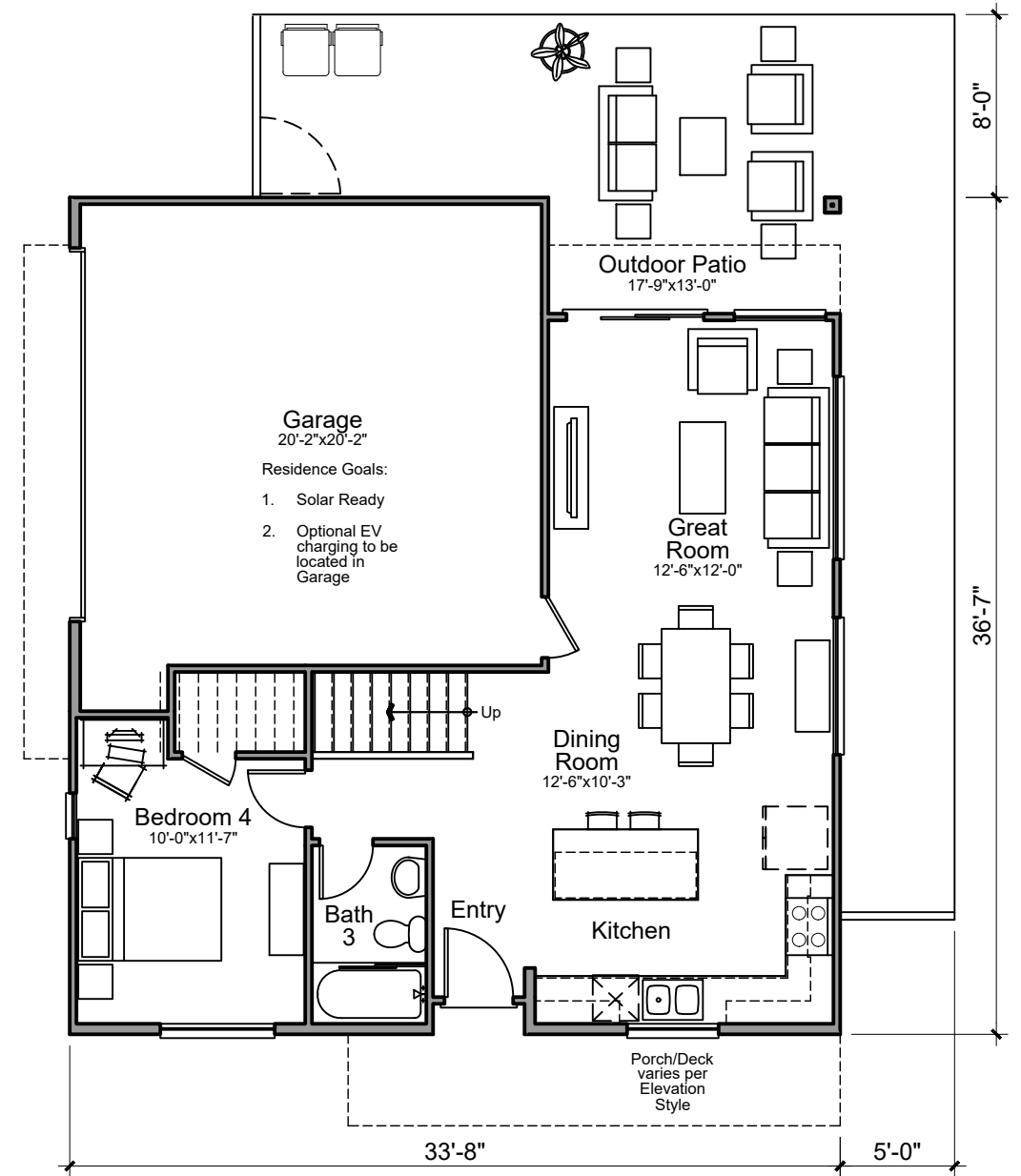

First Floor

PLAN 3 (4 BED / 3 BATH)	
FIRST FLOOR	730 SQ. FT.
SECOND FLOOR	1127 SQ. FT.
TOTAL	1,858 SQ. FT.



Soni 2012 Irrevocable Trusts

1423 Georgina Avenue Santa Monica
 Santa Monica, CA 90402
 (848) 922-7075
 Contact: Vanita Soni Puri

CA ENGINEERING, INC.

Planning • Engineering • Surveying
 13821 NEWPORT AVE., STE 110
 TUSTIN, CA 92780
 949-724-9480 949-724-9484 FAX



SITE SCAPES

Landscape Architecture & Planning
 3180-82 Airport Loop Drive
 Costa Mesa, CA 92626
 Richard Fishman, License # 2782
 (949) 644-9370 FAX (714) 210-3140

Scale: 1/8" = 1'-0"

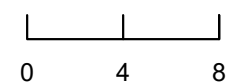

MADERA AT CITRUS TRAIL
 SPECIFIC PLAN

EXHIBIT 19
ARCHITECTURAL STYLES



CORBEL DETAILS
 WINDOW TRIM
 TRIM
 WAINSCOT BAND
 EXTERIOR PLASTER SURROUND
 KICKERS

STYLE A



CORBEL
 BOARD AND BATTEN
 AWNING
 KICKERS
 SIDING
 SHUTTERS
 EXTERIOR LIGHTING
 METAL ROOF
 POSTS

STYLE B



MONTEREY BALCONY
 METAL ROOF
 SHUTTERS
 BRICK
 CORBELS

STYLE C



WOOD SIDING
 SHUTTERS
 PORCH WITH KICKERS

STYLE D



Soni 2012 Irrevocable Trusts
 1423 Georgina Avenue Santa Monica
 Santa Monica, CA 90402
 (848) 922-7075
 Contact: Vanita Soni Puri

CA ENGINEERING, INC.
 Planning • Engineering • Surveying
 13821 NEWPORT AVE., STE 110
 TUSTIN, CA 92780
 949-724-9480 949-724-9484 FAX



SITE SCAPES
 Landscape Architecture & Planning
 3190-82 Airport Loop Drive
 Costa Mesa, CA 92626
 Richard Fishman, License # 2782
 (949) 644-9370 FAX (714) 210-3140

MADERA AT CITRUS TRAIL
 SPECIFIC PLAN

EXHIBIT 20

INTERIOR STREETScape SCENE



Soni 2012 Irrevocable Trusts

1423 Georgina Avenue Santa Monica
 Santa Monica, CA 90402
 (848) 822-7075
 Contact: Vanita Soni Puri

CA ENGINEERING, INC.

Planning • Engineering • Surveying
 13821 NEWPORT AVE., STE 110
 TUSTIN, CA 92780
 949-724-9480 949-724-9484 FAX



SITE ESCAPE

Landscape Architecture & Planning
 3190-82 Airport Loop Drive
 Costa Mesa, CA 92626
 Richard Fishman, License # 2782
 (949) 444-9370 FAX (714) 210-3140

**MADERA AT CITRUS TRAIL
 SPECIFIC PLAN**



Soni 2012 Irrevocable Trusts

1423 Georgina Avenue Santa Monica
 Santa Monica, CA 90402
 (849) 822-7075
 Contact: Vanita Soni Puri

CA ENGINEERING, INC.

Planning • Engineering • Surveying
 13821 NEWPORT AVE., STE 110
 TUSTIN, CA 92780
 949-724-9480 949-724-9484 FAX



SITE ESCAPE
 Landscape Architecture & Planning

3190-82 Airport Loop Drive
 Costa Mesa, CA 92626
 Richard Fishman, License # 2782
 (949) 644-9370 FAX (714) 210-3140

**MADERA AT CITRUS TRAIL
 SPECIFIC PLAN**

EXHIBIT 21

COMMUNITY EDGE ENHANCEMENTS (WABASH AVENUE)



[2] WABASH AVENUE

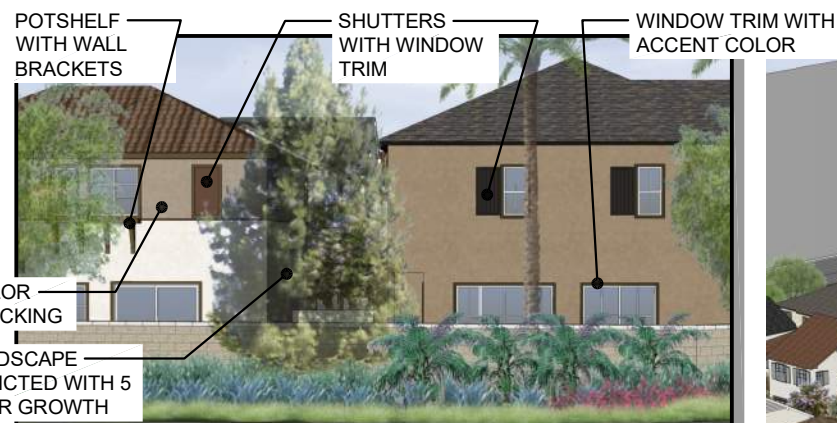

COMMUNITY EDGE ENHANCEMENTS

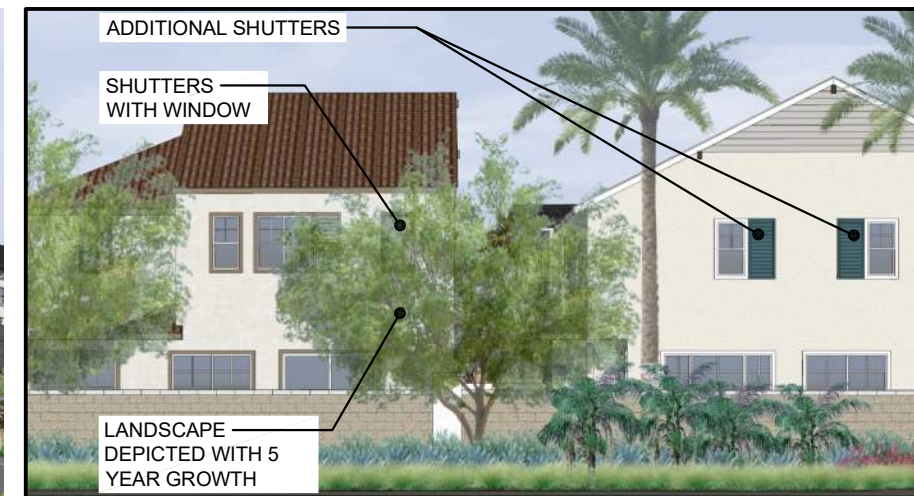

COMMUNITY EDGE ENHANCEMENTS



COMMUNITY EDGE ENHANCEMENTS



COMMUNITY EDGE ENHANCEMENTS



COMMUNITY EDGE ENHANCEMENTS



Soni 2012 Irrevocable Trusts

1423 Georgina Avenue Santa Monica
 Santa Monica, CA 90402
 (849) 822-7075
 Contact: Vanita Soni Puri

CA ENGINEERING, INC.

Planning • Engineering • Surveying
 13821 NEWPORT AVE., STE 110
 TUSTIN, CA 92780
 949-724-9480 949-724-9484 FAX



SITE SCAPES

Landscape Architecture & Planning
 3190-B2 Airport Loop Drive
 Costa Mesa, CA 92626
 Richard Foltmann, License # 2782
 (949) 644-9370 FAX (714) 210-3140

**MADERA AT CITRUS TRAIL
 SPECIFIC PLAN**

EXHIBIT 22

COMMUNITY EDGE ENHANCEMENTS (COLTON AVENUE)



[1] COLTON AVENUE



COMMUNITY EDGE ENHANCEMENTS

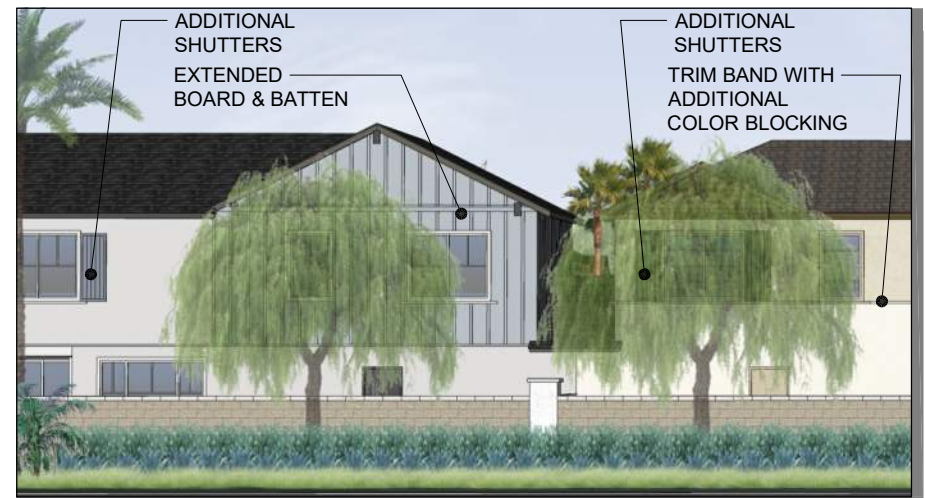

COMMUNITY EDGE ENHANCEMENTS



COMMUNITY EDGE ENHANCEMENTS



COMMUNITY EDGE ENHANCEMENTS



Soni 2012 Irrevocable Trusts
 1423 Georgina Avenue Santa Monica
 Santa Monica, CA 90402
 (949) 922-7075
 Contact: Vanita Soni Puri

CA ENGINEERING, INC.
 Planning • Engineering • Surveying
 13821 NEWPORT AVE., STE 110
 TUSTIN, CA 92780
 949-724-9480 949-724-9484 FAX



MADERA AT CITRUS TRAIL
 SPECIFIC PLAN

SECTION 3. DEVELOPMENT STANDARDS

The Development Standards for Specific Plan No. 66 have been designed to ensure the proper and orderly development of the project site into a unique neo-traditional master planned community. These development standards shall apply to all land and buildings within the project boundaries.

1. Permitted Uses - The principal permitted use is single family residential.
2. Accessory Uses - Accessory uses listed in Section 18.40.040 of the Redlands Municipal Code are permitted.
3. Property Development Standards
 - a. Minimum lot area - The project has been designed as a condominium subdivision, therefore, no minimum lot size and dimensions is required.
 - b. Minimum lot dimensions - No minimum lot and depth is required.
 - c. Maximum coverage by structures - The maximum coverage by structures shall be eighty (80) percent of the lot area.
 - d. Maximum building height - The maximum building height shall be two stories or thirty-five (35) feet.
 - e. Building setbacks:
 - Front yard - Each building shall have a twenty-five (25) foot setback to a public street (Wabash and Colton Avenues).
 - Side yard - No minimum side yard is required.
 - Rear yard - Each lot shall have a minimum rear yard of five (5) feet.
 - Motor court - Each lot shall have a minimum motor court setback of three (3) feet.

SECTION 4. PROCEDURAL IMPLEMENTATION

A. Specific Plan

Specific Plan No. 66, has been prepared and processed pursuant to the Specific Plan guidelines of the City of Redlands. An amendment to the adopted Specific Plan shall require the same procedures as the adoption.

B. In conjunction with the processing of the Specific Plan, Tentative Tract Map No. 20571 has been prepared as the primary implementation tool for the project. Tentative Tract Map No. 20571 sets forth the lot configuration, street design, easements and overall site planning for the project. Following approval of the Tentative Tract Map, the applicant shall prepare the Final Tract Map and accompanying civil engineering plans for final approval by the City. The Tentative and Final Tract Map are being processed in conformance with Chapter 17 of the Redlands Municipal Code, Subdivision Ordinance.

C. A Commission Review and Approval (CRA) No. 965 has been filed in conjunction with Specific Plan No. 66 and Tentative Tract Map No. 20571. The CRA is utilized by the City of Redlands as a land use permit that authorizes the construction of a new building for a permitted use. Specific criteria for a CRA are listed in the Redlands Municipal Code. The application for the construction of the single family residences shall be reviewed by the Planning Commission and shall include preliminary site plans, architectural elevations and floor plans, types of materials and colors to be utilized, locations and types of walls and fences, and a conceptual landscape plan (including types and sizes of plants).

D. Phasing and Maintenance - The project will provide three distinct floor plans all of which will be developed during the initial phase of development. Therefore, all grading, infrastructure, and home construction will be provided during one phase of construction. Individual home construction will proceed as project sales and absorption continues through to project completion.

A series of private streets and parks and open space will be constructed and maintained by a Homeowner's Association.